

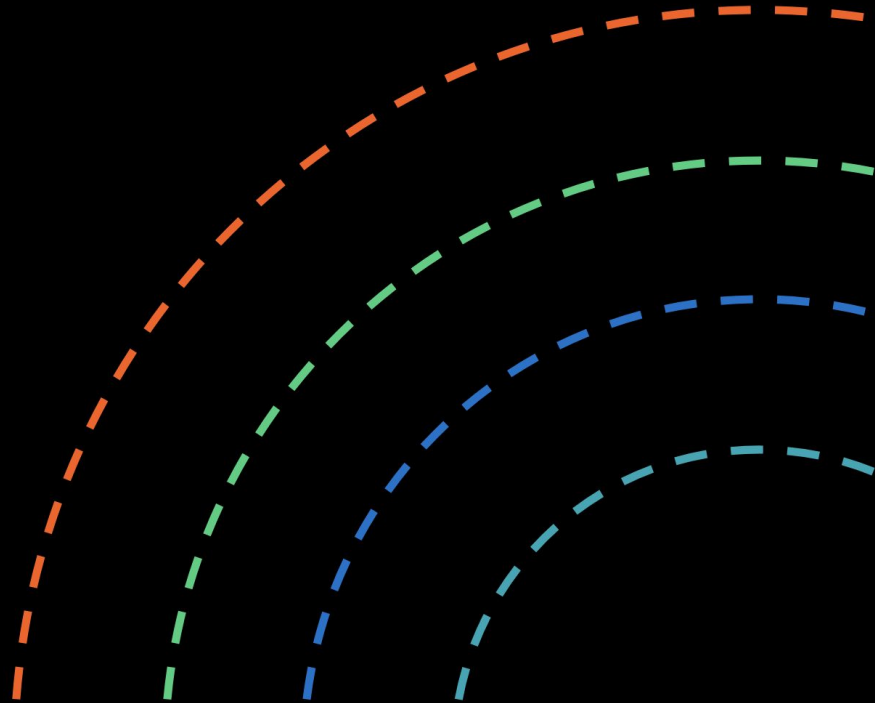

Orchestrate the Chaos:

Process automation in modern architectures

Denver JUG / October 9, 2024



Poll



- How many here use microservice architectures?
- Has anyone struggled to explain data flow/logic between technical and non-technical teams?
- Has anyone heard of BPMN? DMN? BPM?
- Has anyone heard of Camunda?



Who am I?



Samantha Holstine

@sholstine620

she/her

- Developer Advocate @ Camunda
- Denver, CO, United States
- Fun fact: I'm a dance fitness and studio rowing instructor in my free time

What is “Modern Software Architecture”

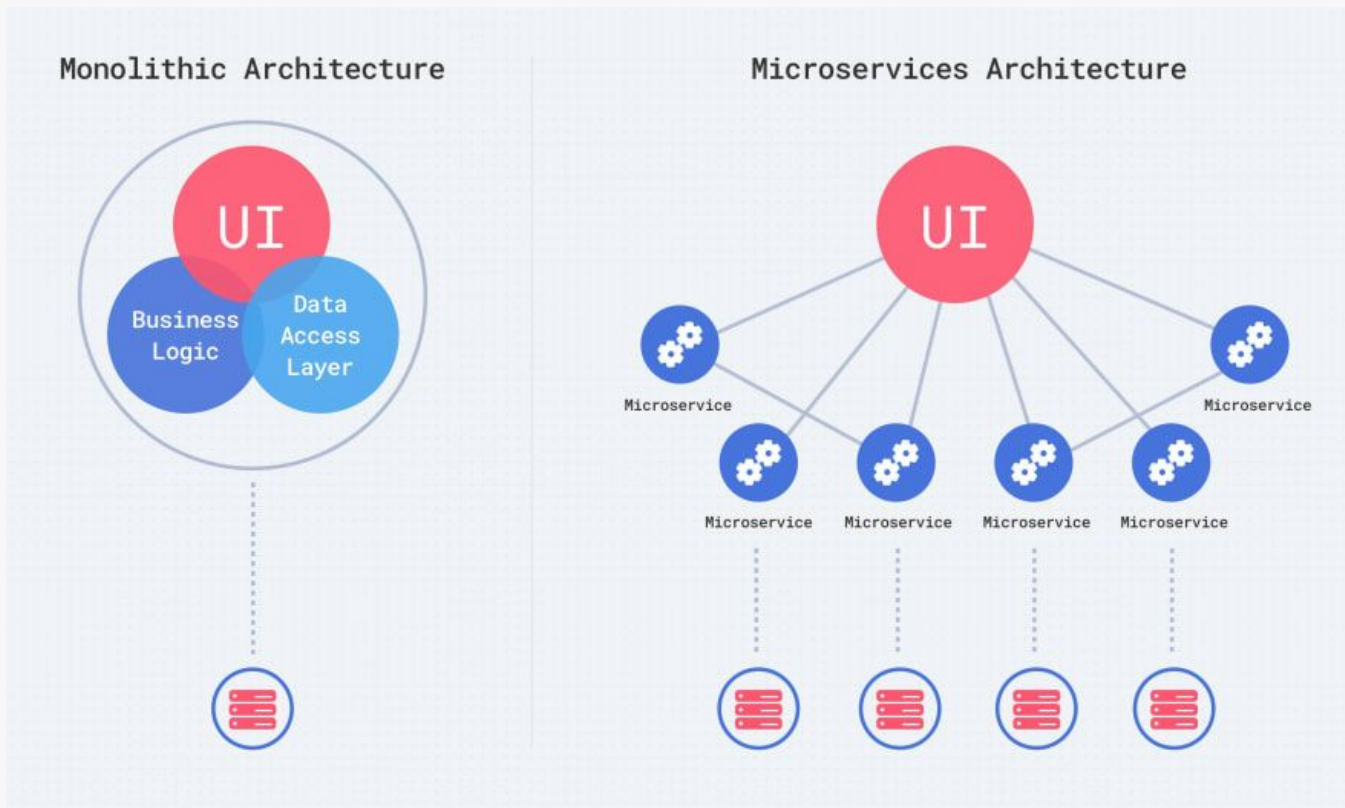

**Modern architecture designs
are great at optimizing
resource usage ...**

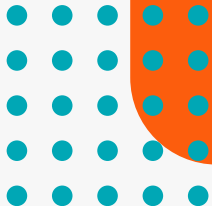

**... now diagram the
business logic / data
flow ...**

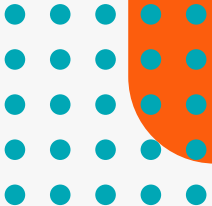

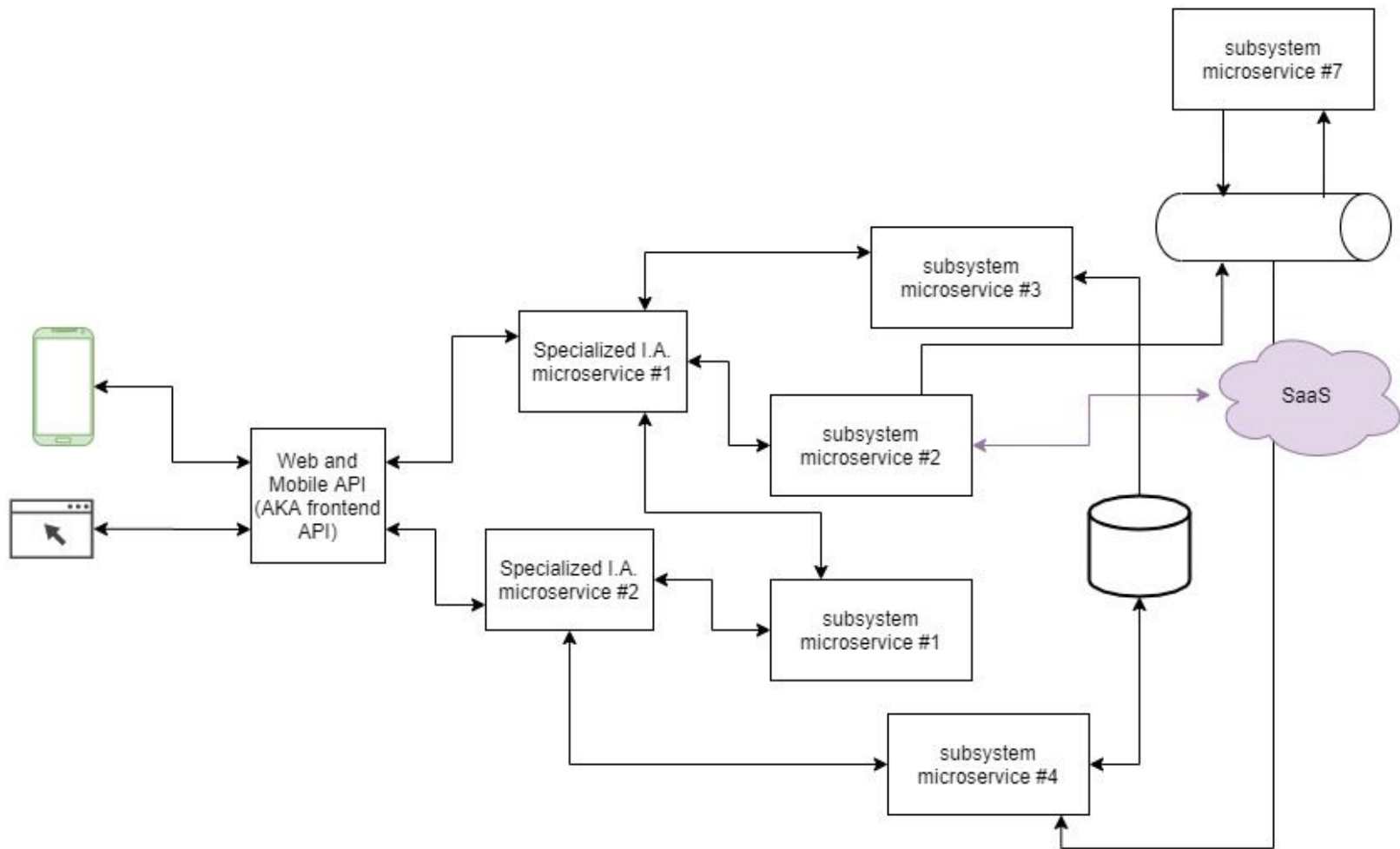



Image: ("Microservices" - KRAZAM) <https://www.youtube.com/watch?v=y8OnoxKotPQ>

Hard problems to solve



Documentation

Data flow diagrams look like spaghetti



Timers

Alerts, stuck/idle processes, notifications



Interrupting messages

Your application is already executing code, but something has changed and you need to interrupt it and handle it differently



Changes to business logic

All your services are running nicely together, but now a new service is added that integrates with other existing services ...

**Forget services and
infrastructure. Let's think
about it in terms of *processes***

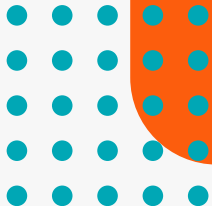

“...a collection of related, structured activities or tasks performed by people or equipment”

Bank Loan Application Approval Process Flow

This slide showcases workflow for bank loan approval process. It also includes process steps such as receiving application, application review, application submission, credit limit evaluation, etc.

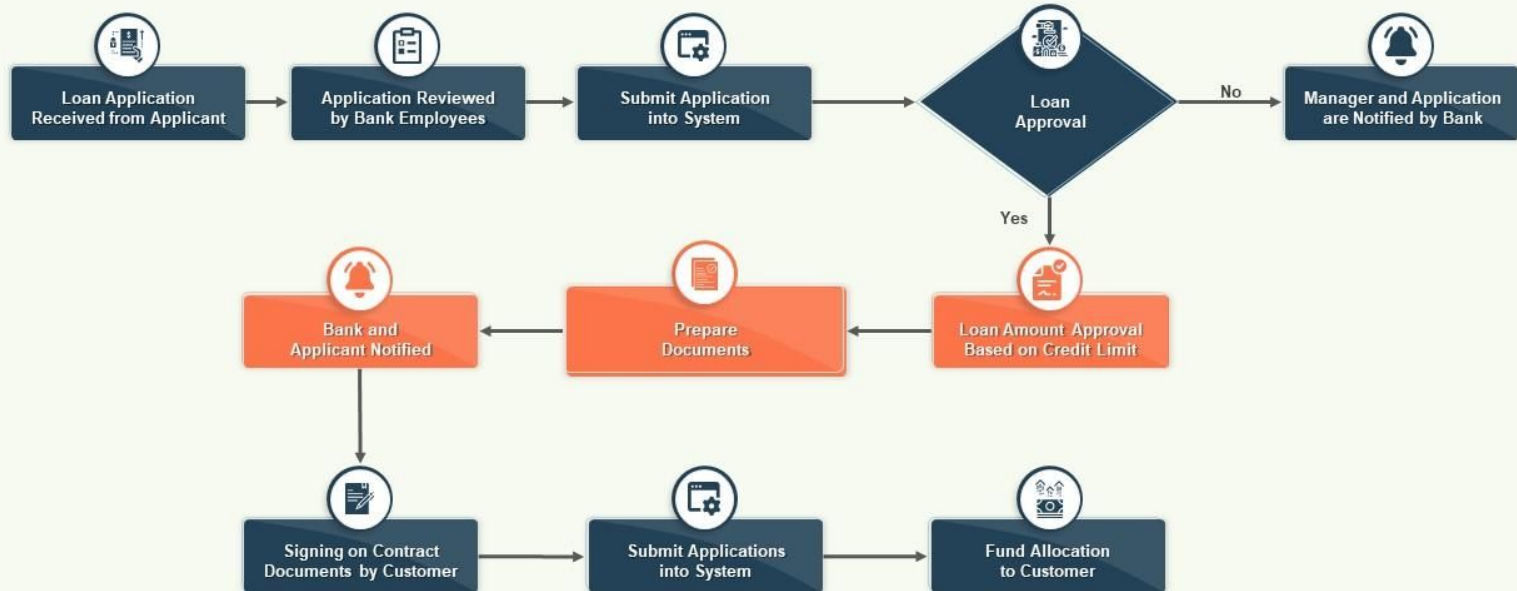

Real World Scenario

Truck Permits

A local municipality needs to issue permits to trucking companies:

- Trucking company fills out a form
- A price is determined for the permit
- The company pays for the permit
- The permit is issued

Truck Permits

A local municipality needs to issue permits to trucking companies:

- Trucking company fills out a form
-> **UserForm microservice**
- A price is determined for the permit
-> **PermitMatch microservice**
- The company pays for the permit
-> **Payments microservice**
- The permit is issued
-> **IssuePermit microservice**

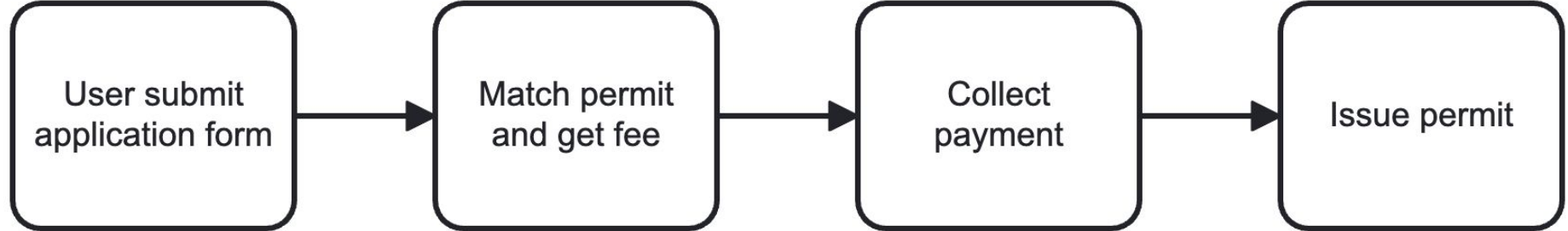

New requirement!



“We need the permit turned into a PDF, and email notifications to the user and to us”

Truck Permits

A local municipality needs to issue permits to trucking companies:

- Trucking company fills out a form
-> **UserForm microservice**
- A price is determined for the permit
-> **PermitMatch microservice**
- The company pays for the permit
-> **Payments microservice**
- The permit is issued
-> **IssuePermit microservice**
-> **PDF microservice**
-> **Email microservice**

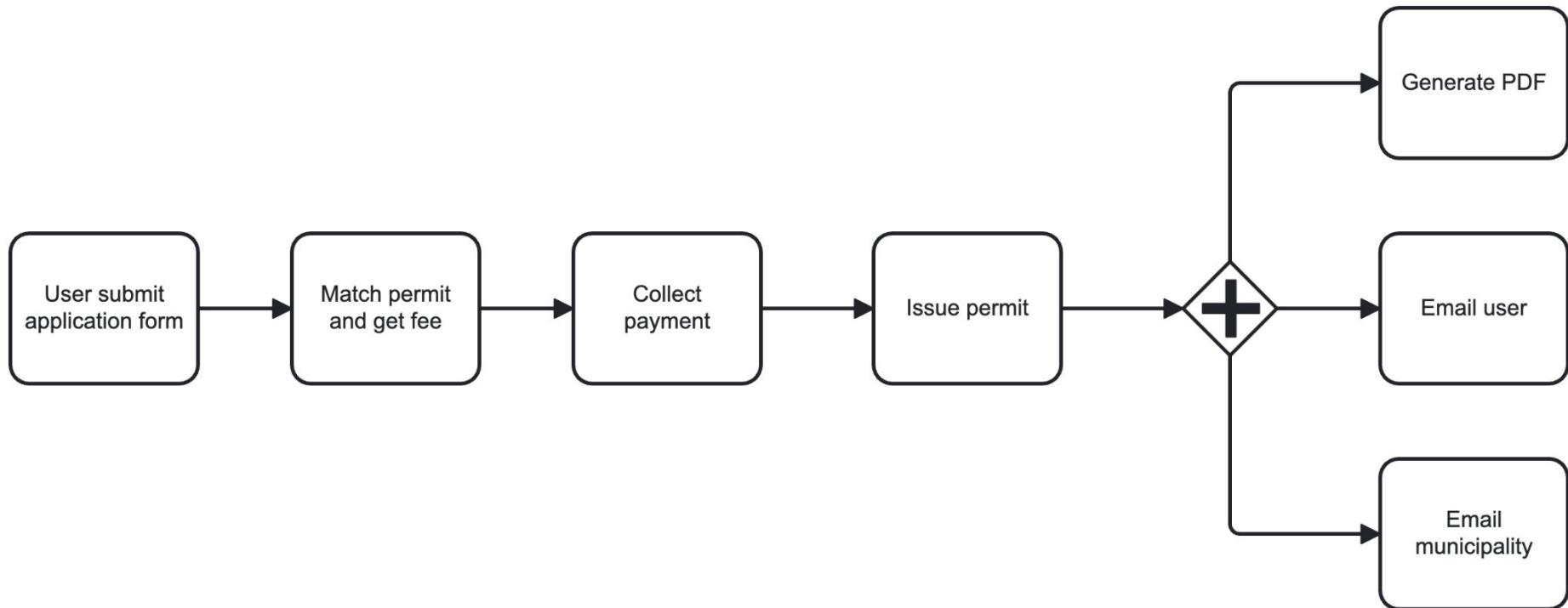

New requirement!



“A user tried to fill in the form, but it didn’t match a permit!”

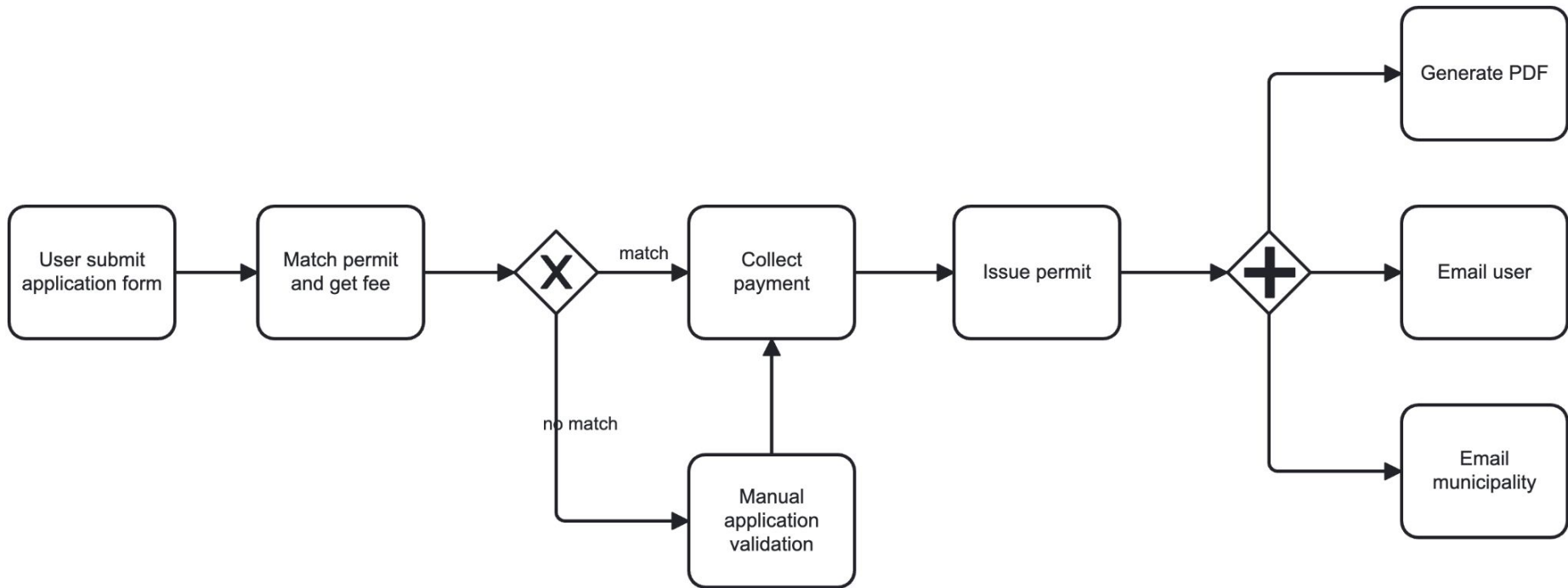

New requirement!

“If they don’t pay in X days,
the permit needs to be
canceled!”

How might you solve this?

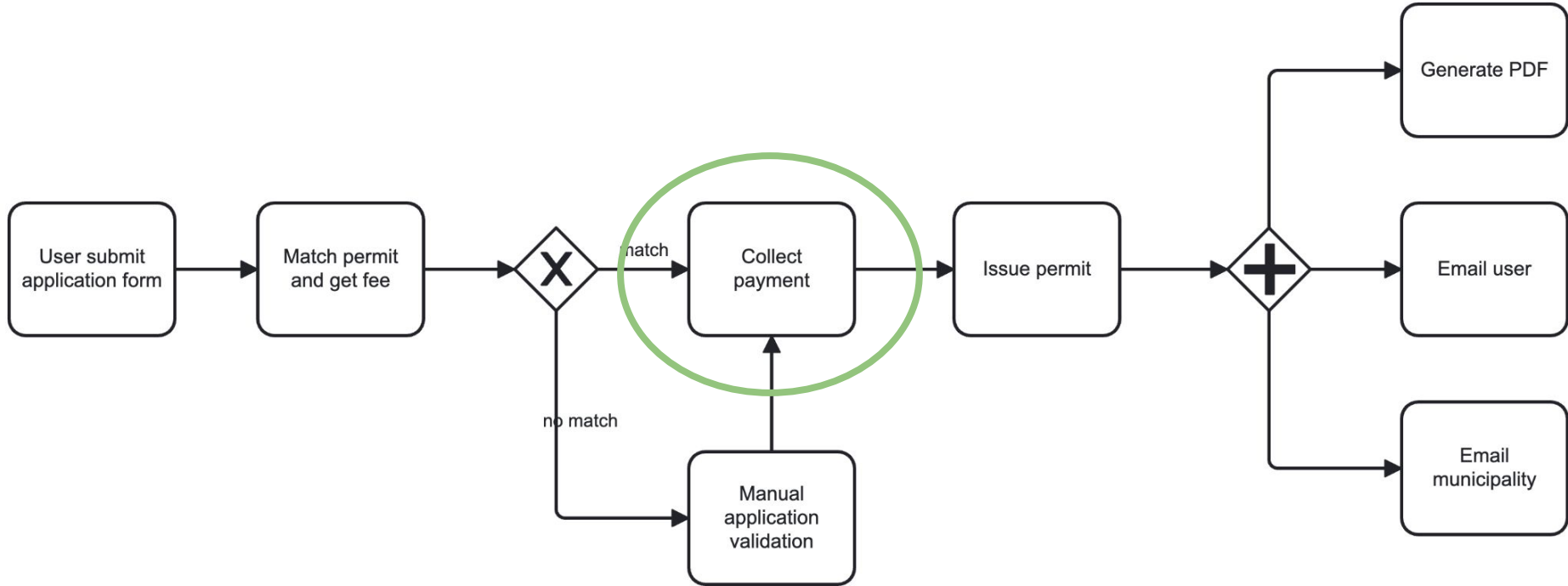

Introducing BPMN

*Business
Process
Model and
Notation*



Maintained spec

ISO/IEC 19510 spec
maintained by OMG
(Object Management
Group)



Visualization

Easily understand
complex processes;
no more spaghetti!



Bridge communication

Simplify discussions
with stakeholders;
unify design and
implementation

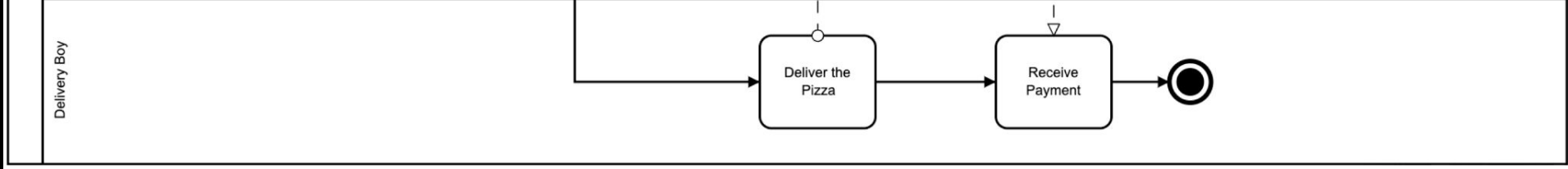
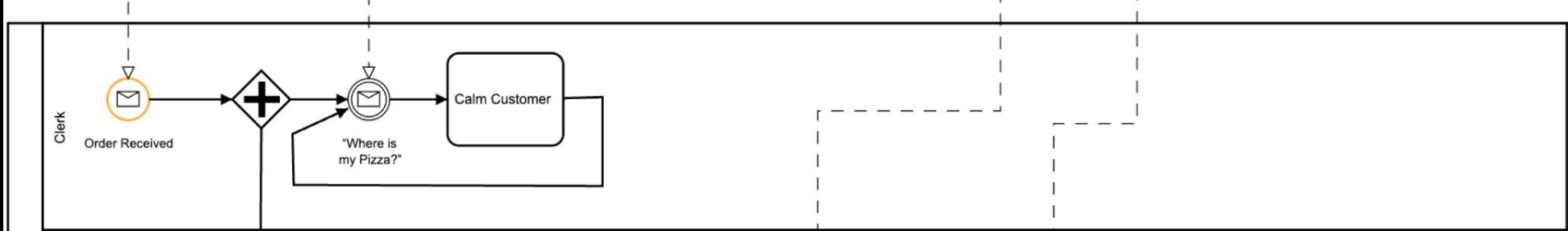
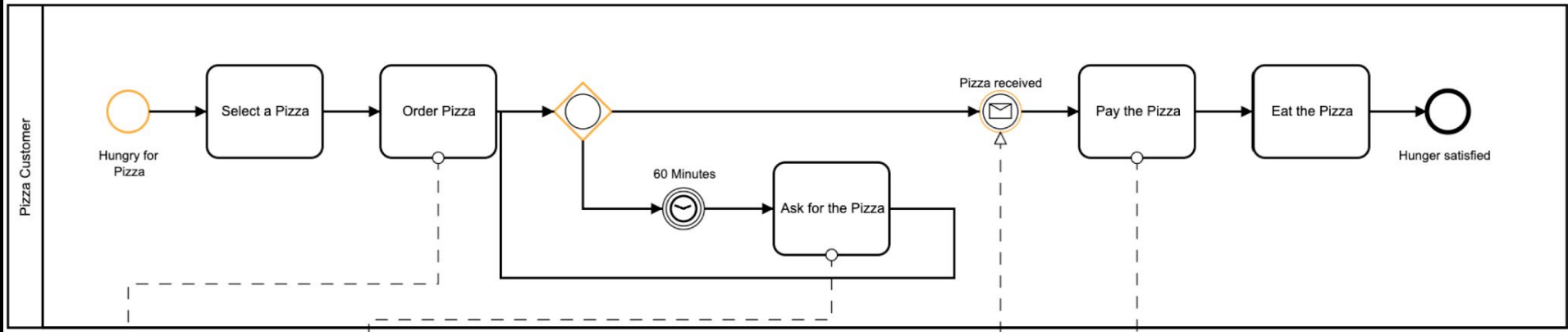

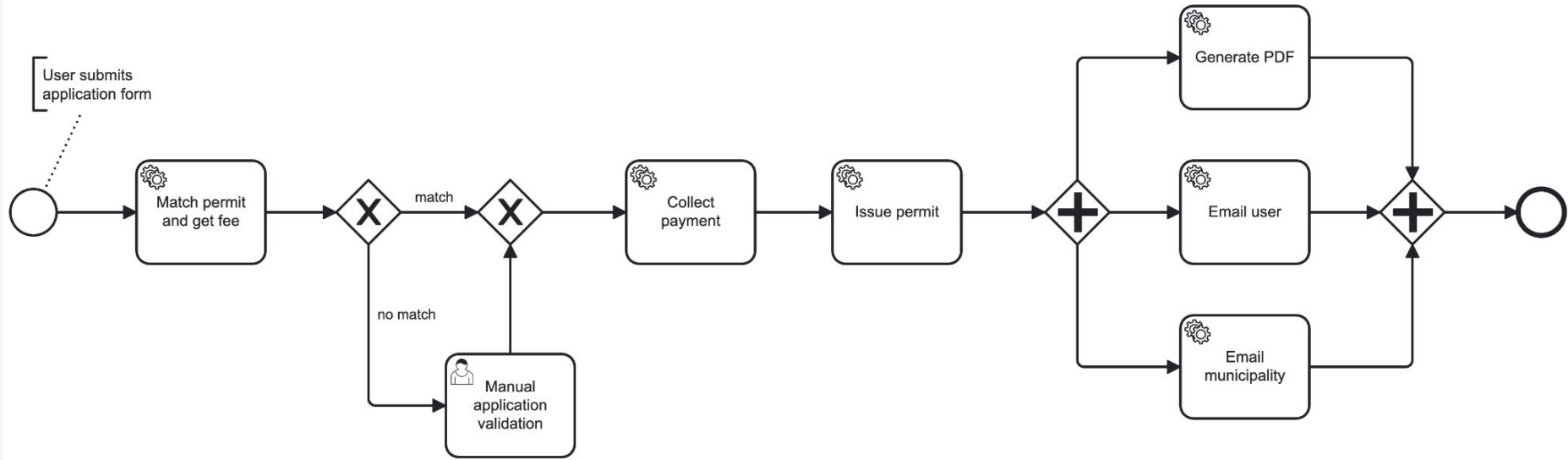

Remember this?

“If they don’t pay in X days,
the permit needs to be
canceled!”

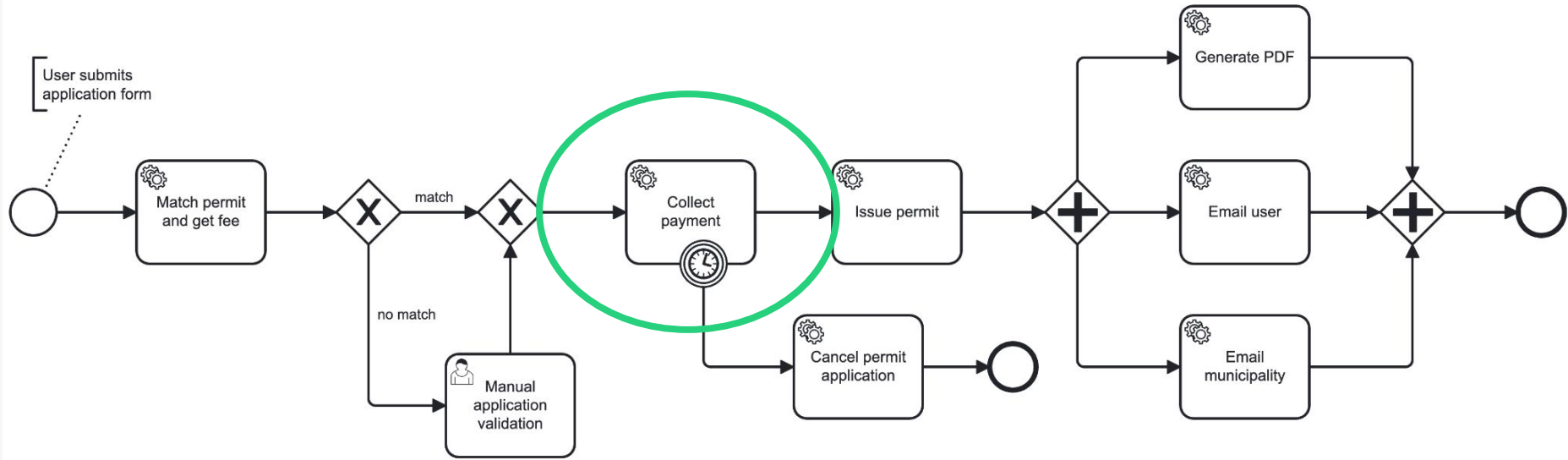

**... That's great, dude, but
that's just a diagram.**

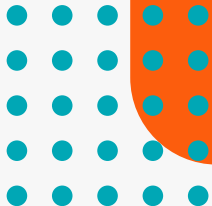

... or is it?!

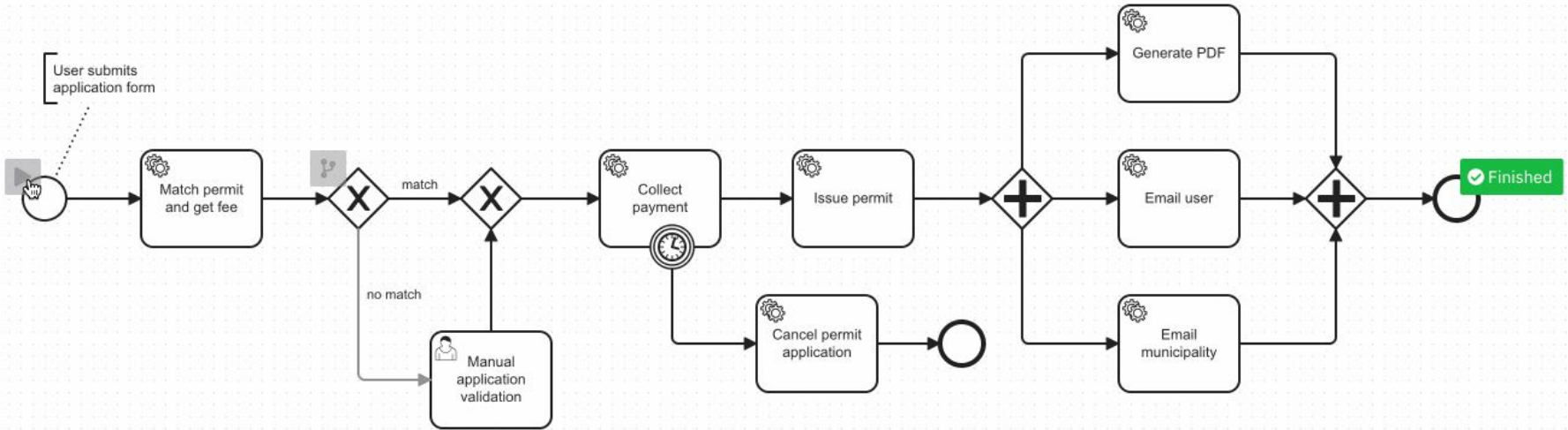

BPMN Engines

(Workflow Management Systems)

Many options to choose from



Vendor	Tool	BPMN 2.0	Import	Export	Roundtrip	Demo Participation	Last Test Submission	A Results Submitted	B Results Submitted	C Results Submitted	Schema-valid	Website
Camunda	bpnm.io (Camunda Modeler) 11.5.0	✔	✔ Diff	✔ Diff	✔ Details	🕒 2022, 2020, 2019, 2018, 2017, 2016, 2015, 2014, 2013	🟢 2023	🟢 24/24	🟢 8/8	🟢 24/24	🟢 14/14	🔗
BOC Group	ADONIS 14.0	✔	✔ Diff	✔ Diff	✔ Details	🕒 2022, 2020, 2019, 2018, 2017, 2016, 2015, 2014, 2013	🟢 2023	🟢 24/24	🟢 8/8	🟢 24/24	🟢 14/14	🔗
Software AG	ARIS 10.0.22	✔	✔ Diff	✔ Diff	✔ Details	🕒 2022, 2020, 2019, 2018	🟢 2023	🟢 24/24	🟢 8/8	🟢 24/24	🟢 14/14	🔗
Esteco S.p.A.	Cardanit (prev. BeePMN) 4.9.1	✔	✔ Diff	✔ Diff	✔ Details	🕒 2022, 2020, 2019, 2018, 2017, 2016	🟢 2023	🟡 16/24	🔴 0/8	🟢 24/24	🟡 6/10	🔗
Trisotech	Trisotech Workflow Modeler 10.15.3	✔	✔ Diff	✔ Diff	✔ Details	🕒 2022, 2020, 2019, 2018, 2017, 2016, 2015, 2014, 2013	🟡 2022	🟢 24/24	🟢 8/8	🟢 24/24	🟢 14/14	🔗
MID GmbH	MID Innovator 15.1.1.11026	✔	✔ Diff	✔ Diff	✔ Details	🕒 2022	🟡 2022	🟢 24/24	🟢 8/8	🟢 24/24	🟢 14/14	🔗
OMNINET	OMNITRACKER BPMN 12.3	✔	✔ Diff	✔ Diff	✔ Details	🕒 2022, 2020	🟡 2022	🟢 24/24	🟢 8/8	🟢 24/24	🟢 14/14	🔗
viadeo Unternehmensberatung AG	BPMN-Modeler for Confluence Enterprise 3.19.0	✔	✔ Diff	✔ Diff	✔ Details	🕒 2022, 2020	🟡 2022	🟡 22/24	🟢 8/8	🟢 24/24	🟢 14/14	🔗
MID GmbH	MID bpanda 2019.05.0.8393	✔	✔ Diff	✔ Diff	✔ Details	🕒 2022	🟡 2019	🟢 24/24	🟢 8/8	🟡 16/24	🟡 11/11	🔗
KnowProcess Limited	KnowProcess 3.0.0-beta-1	✔	✔ Diff	✔ Diff	✔ Details	🕒 2022, 2020, 2019, 2018, 2017, 2016, 2015, 2014, 2013	🟡 2018	🟡 4/24	🟡 2/8	🟡 3/24	🔴 0/0	🔗
Signavio GmbH	Signavio Process Editor 10.0.0	✔	✔ Diff	✔ Diff	✔ Details	🕒 2022, 2020, 2019, 2018, 2017, 2016, 2015, 2014, 2013	🟡 2016	🟢 24/24	🟢 8/8	🟡 16/24	🟡 11/13	🔗
ITESOFT	W4 BPMN+ Composer V.10.4	✔	✔ Diff	✔ Diff	✔ Details	🕒 2020, 2019, 2018, 2017, 2016, 2015, 2014, 2013	🟡 2019	🟢 24/24	🟢 8/8	🟡 20/24	🟡 13/13	🔗
CaseAgile	Enterprise Explorer 1.0.0	✔	✔ Diff	✔ Diff	✔ Details	🕒 2020, 2019, 2018, 2017	🟡 2019	🟢 24/24	🟡 6/8	🟡 22/24	🟡 9/12	🔗
Boris Zinchenko	BPMN View 1.0.7	✔	✔ Diff	🔴	🔴 Details	🕒 2019, 2018, 2017	🟡 2019	🟡 6/24	🟡 2/8	🟡 5/24	🔴 0/0	🔗
Sparx	Enterprise Architect 12.0.1207	✔	✔ Diff	✔ Diff	✔ Details	🕒 2019, 2018, 2015	🟡 2015	🟡 10/24	🟡 4/8	🔴 0/24	🟡 7/7	🔗
W4 Software	W4 BPMN+ Composer V.9.4	✔	✔ Diff	✔ Diff	✔ Details	🕒 2017, 2016, 2015, 2014, 2013	🟡 2016	🟢 24/24	🟢 8/8	🟡 16/24	🟡 11/11	🔗
itp-commerce	itp-commerce Process Modeler for MS Visio 6	✔	✔ Diff	✔ Diff	✔ Details	🕒 2017, 2016, 2015, 2014, 2013	🟡 2015	🟡 20/24	🟢 8/8	🟡 2/24	🟢 8/8	🔗
Camunda	Camunda Eclipse Plugin 3.0.0	✔	✔ Diff	✔ Diff	✔ Details	🕒 2016, 2015, 2014, 2013	🟡 2016	🟡 20/24	🟢 8/8	🟡 16/24	🟡 11/11	🔗
ModelFoundry Pty. Ltd.	ModelFoundry 1.1.1	✔	✔ Diff	✔ Diff	✔ Details	🕒 2016	🟡 2016	🟡 12/24	🟡 4/8	🟡 8/24	🟡 2/11	🔗
Trisotech	Trisotech BPMN Visio Add In 5.0.1	✔	✔ Diff	✔ Diff	✔ Details	🕒 2016, 2015, 2014, 2013	🟡 2015	🟡 20/24	🟢 8/8	🟡 16/24	🟡 11/11	🔗
MODELISOFT / SOFTEAM	Modelio 3.5	✔	✔ Diff	✔ Diff	✔ Details	🕒 2016	🟡 2015	🟡 18/24	🟢 8/8	🟡 16/24	🔴 0/10	🔗
Yaoqiang, Inc.	Yaoqiang BPMN Editor 4.0	✔	✔ Diff	✔ Diff	✔ Details	🕒 2016, 2015, 2014, 2013	🟡 2015	🟢 24/24	🟢 8/8	🟡 4/24	🟡 8/8	🔗
GenMyModel	GenMyModel 0.47	✔	✔ Diff	✔ Diff	✔ Details	🕒 2015	🟡 2015	🟡 16/24	🟢 8/8	🟡 16/24	🟡 7/8	🔗
Alfresco	Activiti Designer 5.14.1	✔	✔ Diff	✔ Diff	✔ Details	🕒 2014	🟡 2014	🟡 12/24	🔴 0/8	🔴 0/24	🟢 3/3	🔗
IBM	IBM BlueWorks Live April 2014	✔	✔ Diff	✔ Diff	🔴 Details	🕒 2014	🟡 2014	🟡 8/24	🔴 0/8	🔴 0/24	🟡 2/2	🔗
Oracle	Oracle BPM Studio 12.1.3	✔	✔ Diff	🔴	🔴 Details	🕒 2014	🟡 2014	🟡 3/24	🔴 0/8	🔴 0/24	🔴 0/0	🔗
GBTEC Software + Consulting AG	BIC Cloud Design 6.2.0	✔	✔ Diff	✔ Diff	✔ Details	🕒 2020	🟡 2020	🟢 24/24	🟡 7/8	🟡 20/24	🟡 11/12	🔗
Bonitasoft	Bonita BPM 7.2.3	✔	✔ Diff	🔴	🔴 Details	🕒 2016	🟡 2016	🟡 21/24	🟡 6/8	🟡 14/24	🟡 3/11	🔗

<https://bpmn-miwig.github.io/bpmn-miwig-tools/>



Camunda - The Universal Process Orchestrator

Orchestrate

Complex process flows across people, systems and devices.

Automate

Any process, anywhere.

Transform

Your organization toward a digital future.

Collaborate

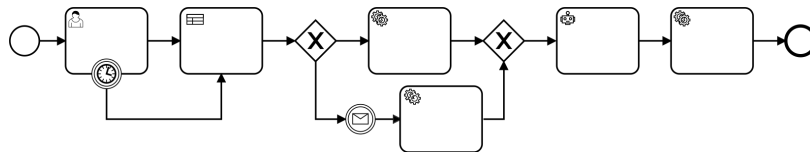

Flexibility



All Endpoints

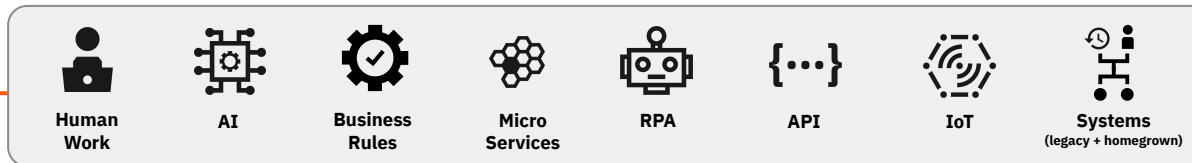

Camunda Platform 8

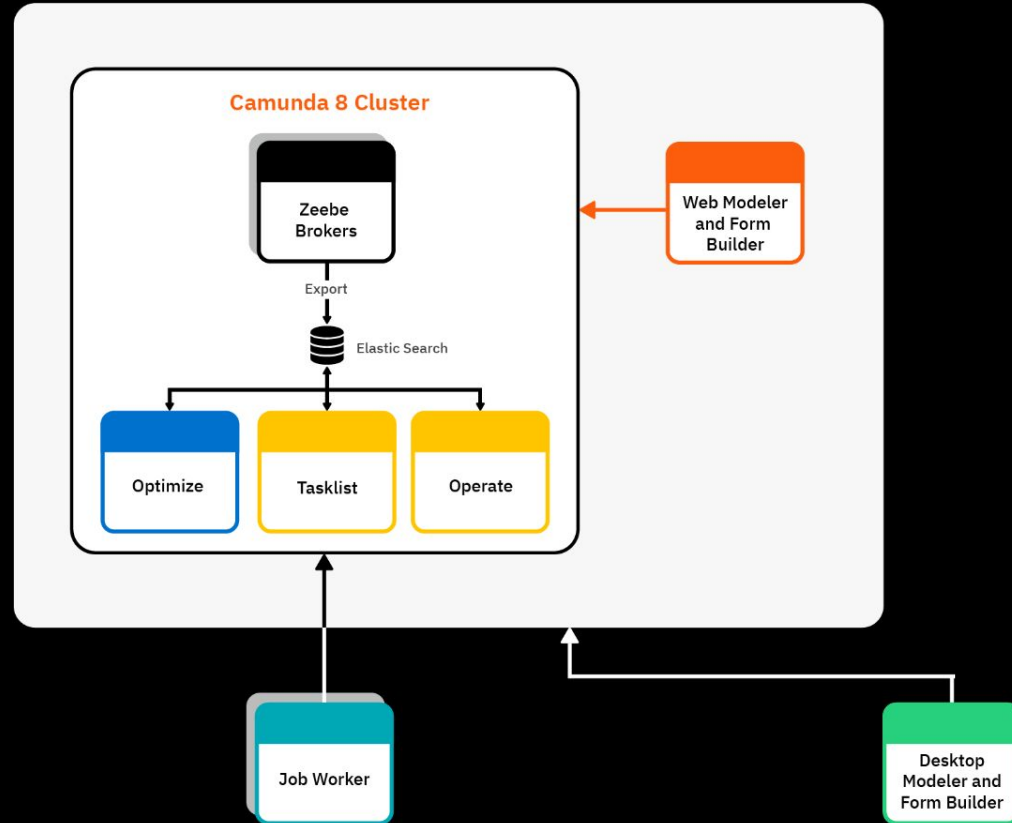

Zeebe Architecture

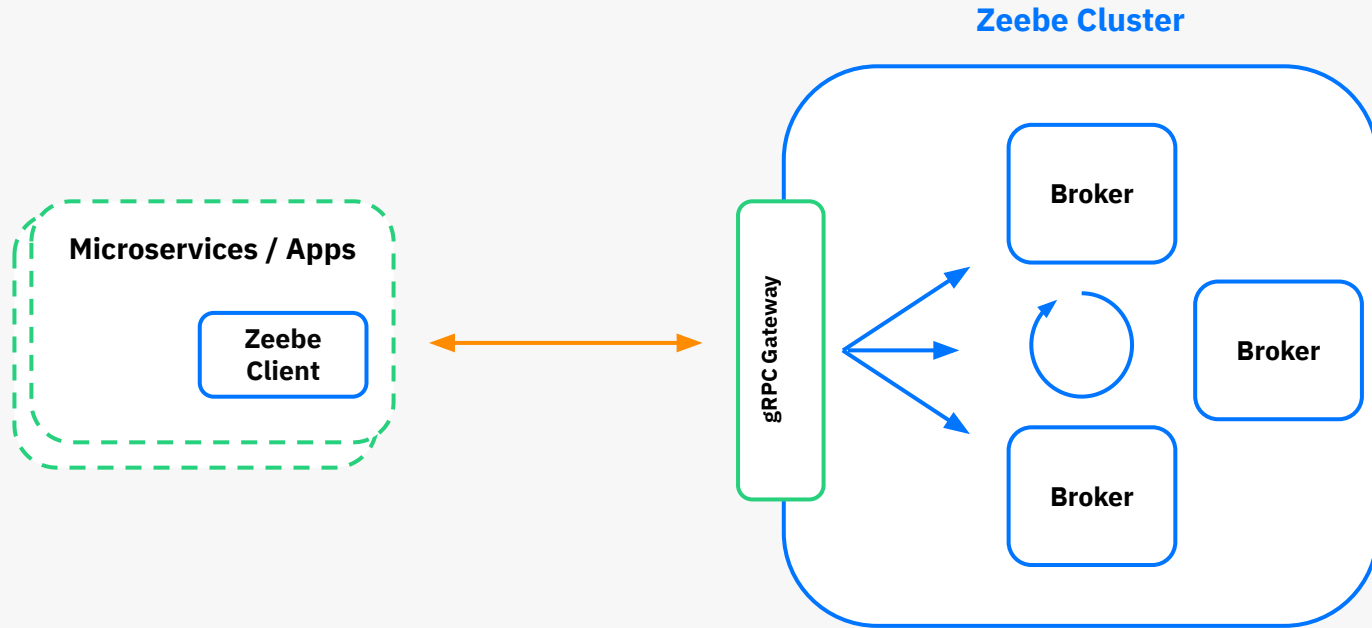

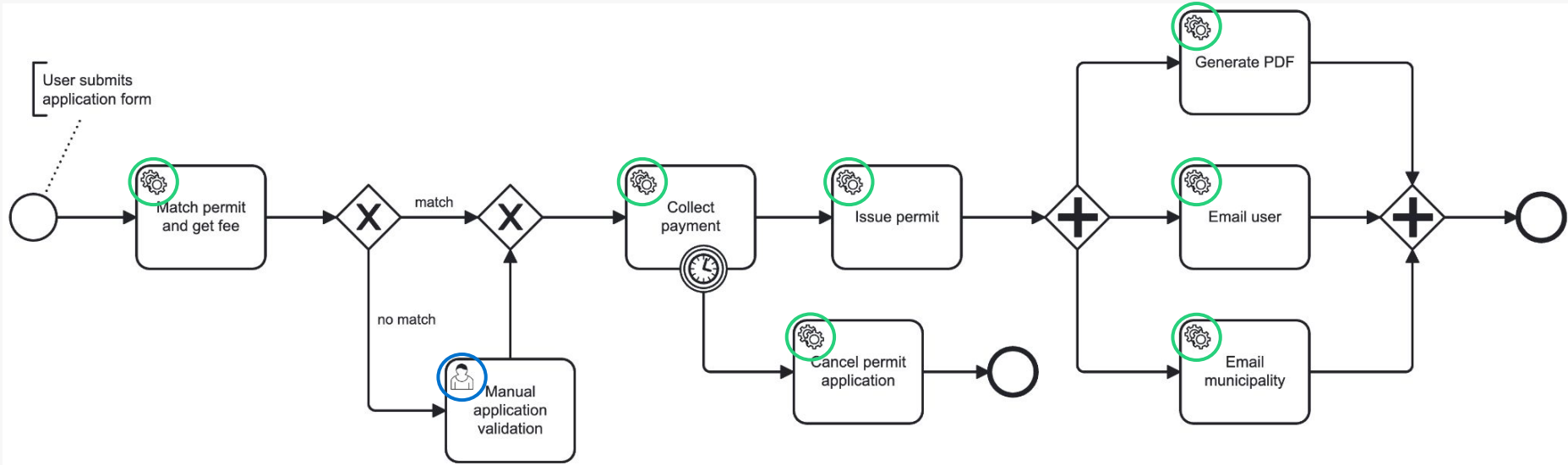

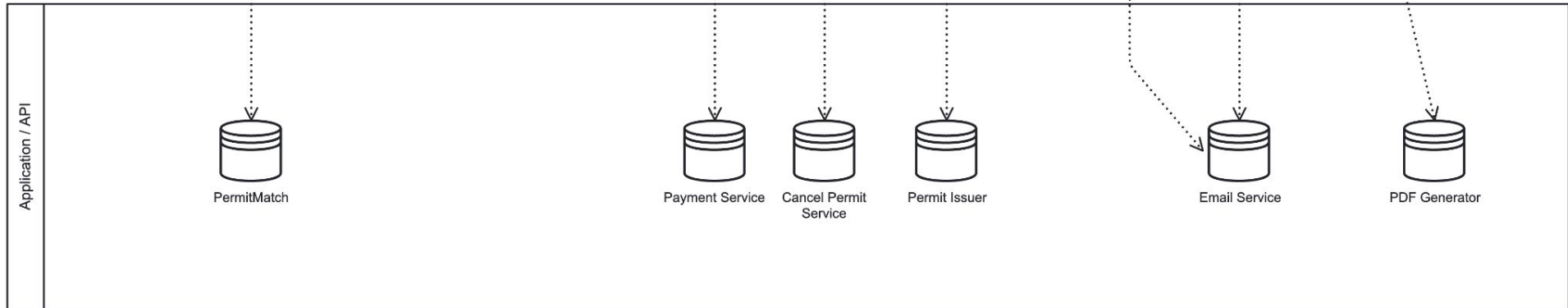
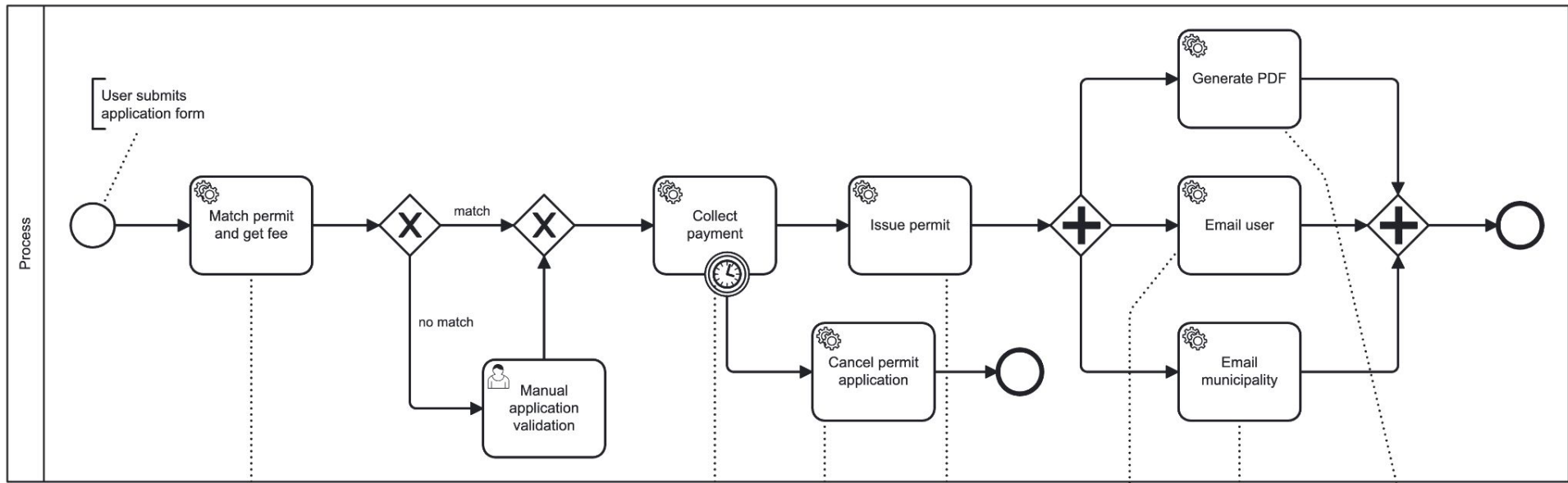

The state of a process is managed by the workflow engine, not the application. The data is managed by the application, not the engine.

New requirement!

“For some permits, they need additional approval before collecting payment.”

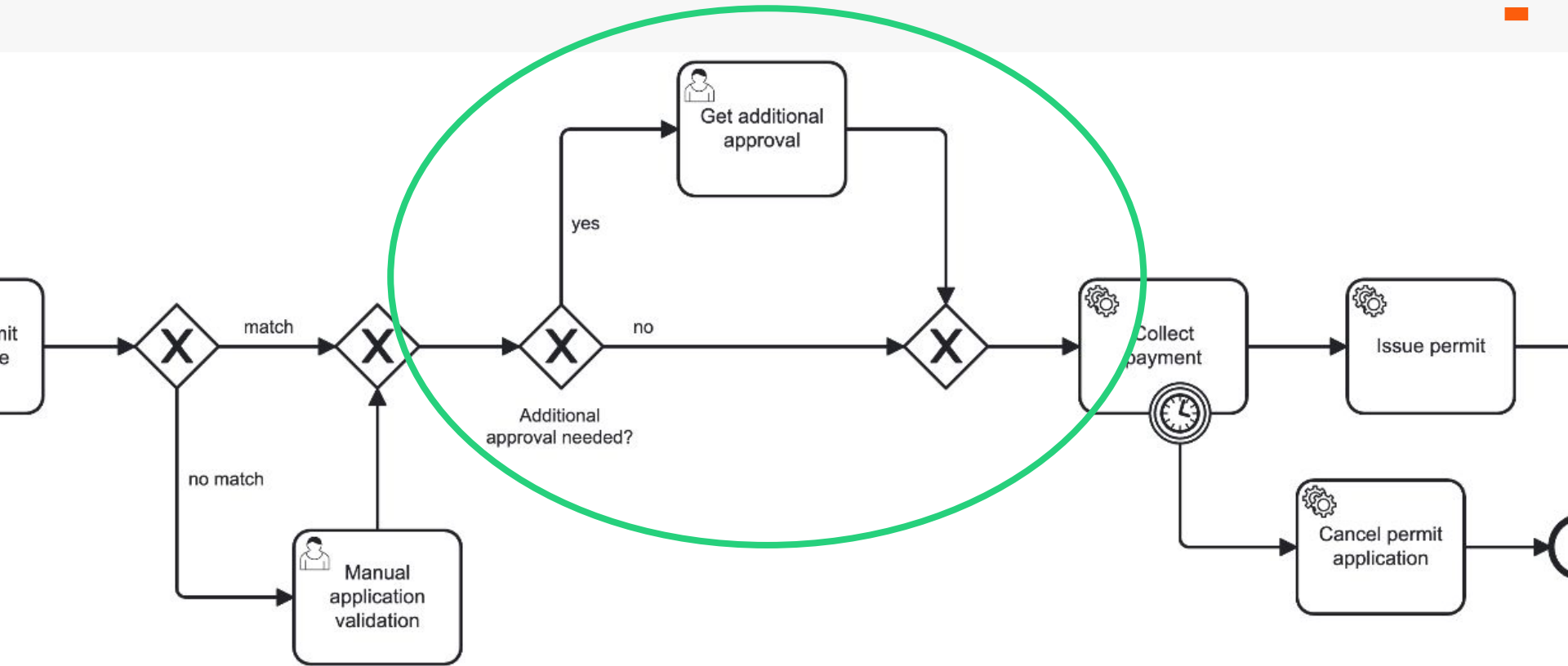

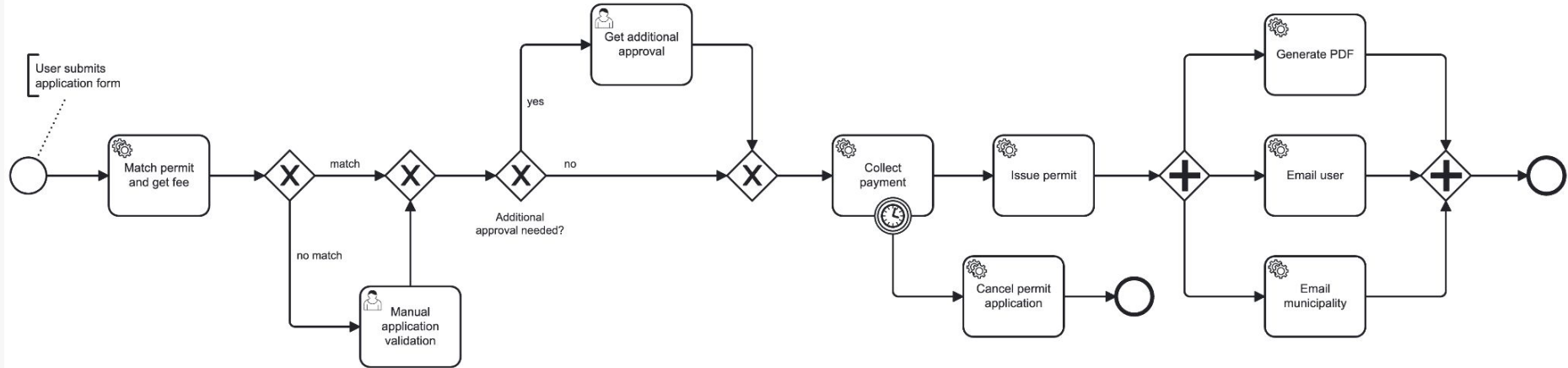

New requirement!

“Oh, and we should probably send a payment reminder before we cancel the permit.”

Errors and reminders

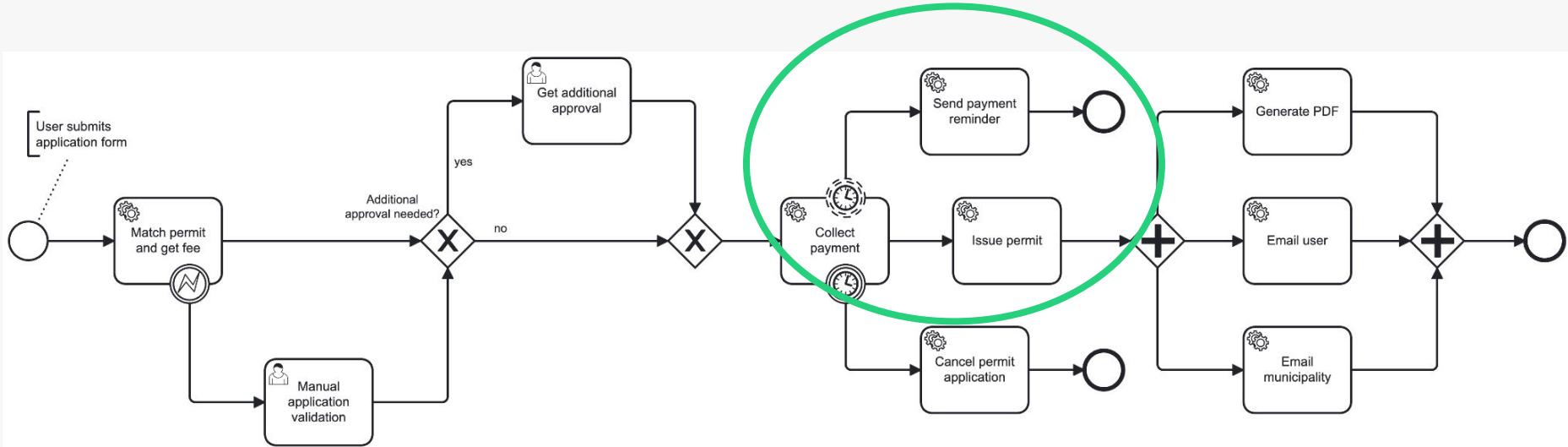

Errors and reminders

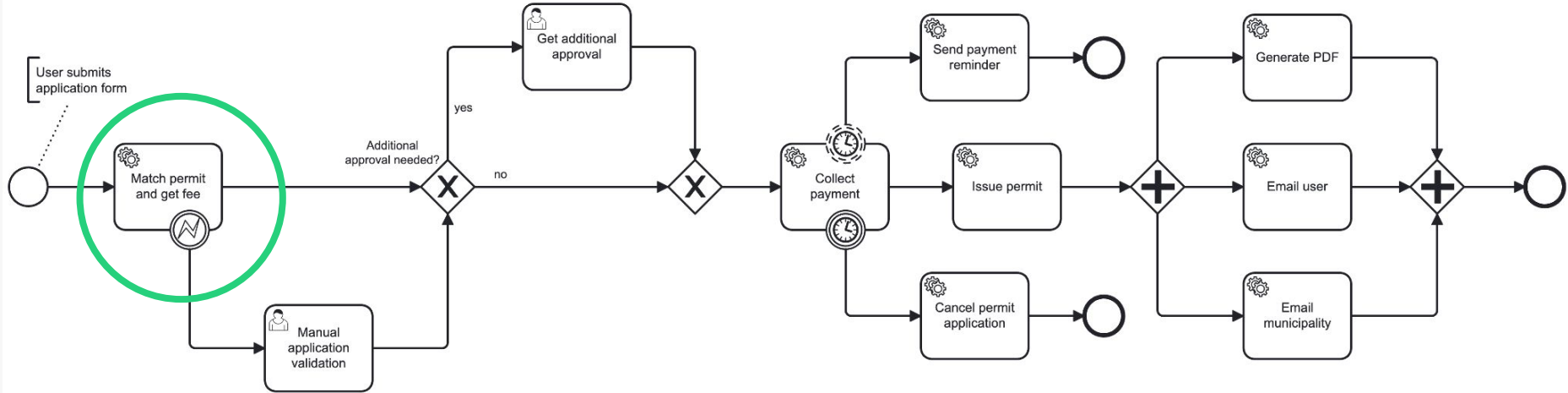

That was easy!

Let's review

1

BPMN

Open spec that defines processes in an organized, understandable way

2

BPMN Engines

Execute the process as drawn, connecting tasks to external services. State of each process is controlled by the engine, not the application.

3

Simplified management

Easily add additional tasks without changing existing application; engines provide management tools to monitor performance etc.



Resources

- Camunda Academy – free courses on BPMN and Camunda:
<https://academy.camunda.com/>
- BPMN 2.0 documentation:
<https://docs.camunda.io/docs/components/modeler/bpmn/bpmn-primer/>
- Camunda Code Studio on YouTube:
<https://www.youtube.com/watch?v=fv3wPccIpL8>
- Camunda Forum:
<https://forum.camunda.io/>





**CAMUNDA
CON 2024**

Join us in New York City or Online October 16-17

**THE PROCESS
ORCHESTRATION
CONFERENCE**

Questions?