

What's new in WCAG 2.2

Candidate Recommendation

Allison Ravenhall

 RavenAlly

9 new success criteria

2 x A, 5 x AA, 2 x AAA

5 x Operable, 4 x Understandable

**3 x Navigable, 2 x Input Modalities,
1 x Predictable, 3 x Input Assistance**



Redundant Entry

A

Shipping address is the same as billing address



Consistent Help

A

- Phone number & hours
- Contact form
- Email address
- Chatbot
- Human messaging
- Frequently Asked Questions
- Support / help pages
- Social media channels





Focus Not Obscured

AA / AAA



Find a Store

Find your local Bupa store and their opening hours.

Find a Bupa Store



Visit MyBupa

Manage and view your membership details anytime anywhere.

Log in / register for myBupa



Bupa Aged Care

Visit the Bupa Aged Care website for more information

Bupa Aged Care

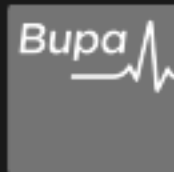

At Bupa we're always looking for more ways to care for you. We offer quality insurance, aged care and a network of dental, optical, hearing and therapy services.

Download myBupa



Insurance

- Health Insurance
- Overseas Health Cover
- Corporate plans
- Travel Insurance
- Car Insurance
- Home Insurance
- Pet Insurance
- Landlords Insurance
- Valuables Insurance

Services

- Aged Care
- Bupa Dental
- Bupa Optical
- Bupa Hearing
- Bupa Medical Visa
- Telehealth

Get Help

- Healthlink
- Find a healthcare provider
- For providers
- Health programs
- Find a Bupa centre

Company

- About us
- Careers
- Newsroom
- Contact us

Message us

Today

Hi, welcome to Bupa Messaging!
Are you an existing Bupa Member?

Yes, I am No, I am not

Type your message



Longer, healthier, happier lives. Bupa

AA ✓

AAA ✗

Get Help

Healthlink

Find a healthcare provider

For providers

Health programs

Find a Bupa centre

Company

About

Careers

Newsroom

Contact

Message us



Today

Hi, welcome to Bupa Messaging!
Are you an existing Bupa Member?

Yes, I am

No, I am not

Longer, healthier, happier lives.

Bupa



Type your message





Dragging Movements

AA

Isn't this covered in 2.5.1 Pointer Gestures?

No, dragging is not path-based.

Is meeting 2.1.1 Keyboard good enough?

No, this is specifically for pointer interfaces.

Search Google Maps

- Restaurants
- Hotels
- Things to do
- Museums
- Transport
- Chemists

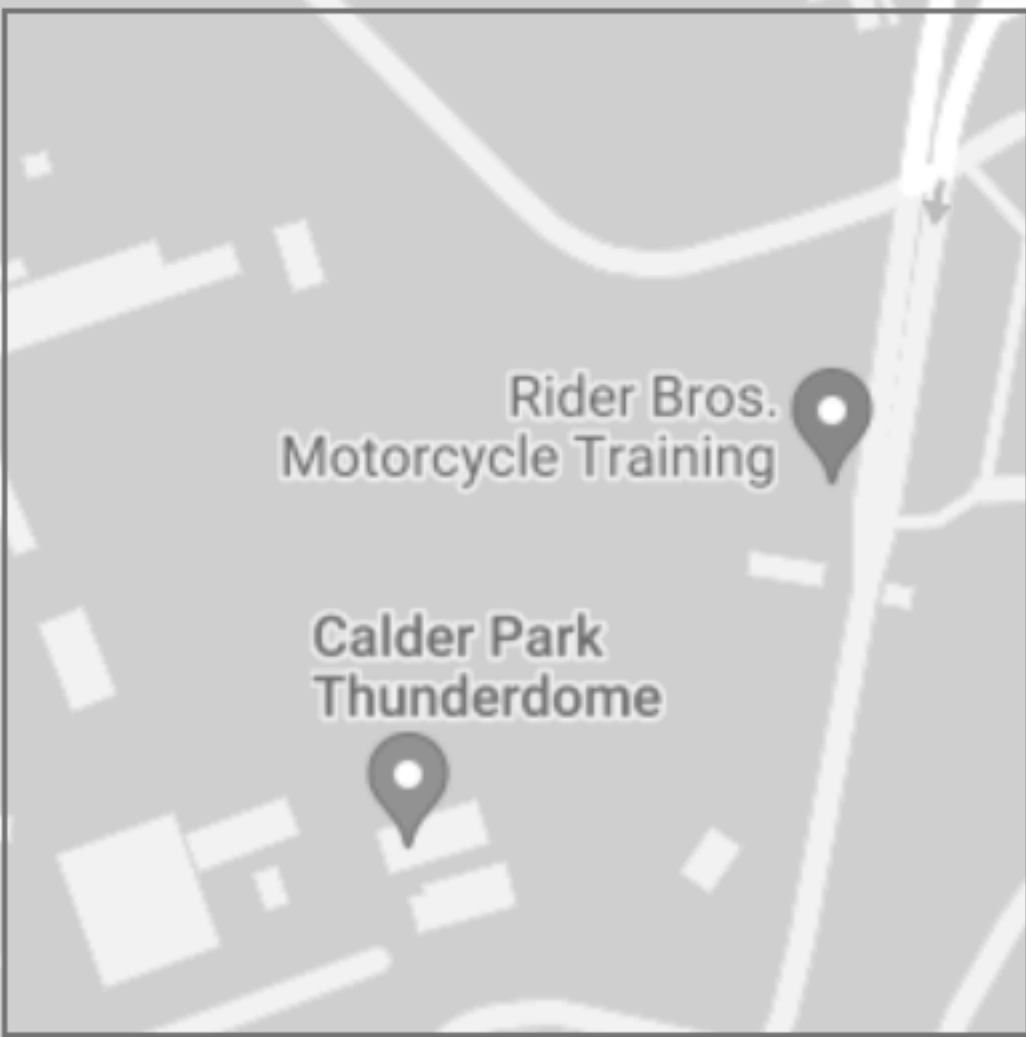
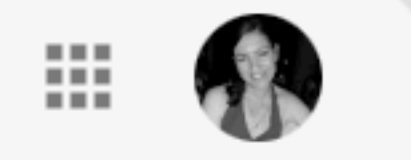

Indian Music Warehouse
Musical instrument store





- 1 Calder Park Thunderd...
- 2 Rider Bros. Motorcycl...



Calder Park

Board

  4 days remaining

Complete sprint 



Epic 

GROUP BY Choices 

TO DO 12

Implement feedback collector

 NUC-205 9  

Bump version for new API for billing

 NUC-206 3  

Add NPS feedback to wallboard

 NUC-208 1  

IN PROGRESS 4

Update T&C copy with v1.9 from the writers guild in all products that have cross country compliance

 NUC-213  1  

Tech spike on new stripe integration with paypal

 NUC-215 3  

Refactor stripe verification key validator to a single call to avoid timing out on slow connections

 NUC-216 3  

Change phone number field type to 'phone'

 NUC-217  1  

IN REVIEW 4

Multi-dest search UI web

 NUC-338 5  

DONE 4

Quick booking for accomodations - web

 NUC-336   4  

Adapt web app no new payments provider

 NUC-346   3  

Fluid booking on tablets

 NUC-343  5  

Shoping cart purchasing error - quick fix required.

 NUC-354  1  

▼ Mars Landing! 6 issues

Start Sprint



- = TIS-1 Spaceship tracker app updates 8.0 Mars Landing
- = TIS-2 Verify the landing site
- = TIS-3 Enter the landing trajectory into the landing module Mars Landing 1
- = TIS-4 Send the pre-landing report to Earth Mars Landing 1
- = TIS-5 Cleanup the landing site Mars Landing 2
- = TIS-6 Hire the team 5

+ Create issue

6 issues Estimate 9



Target Size (Minimum)

AA

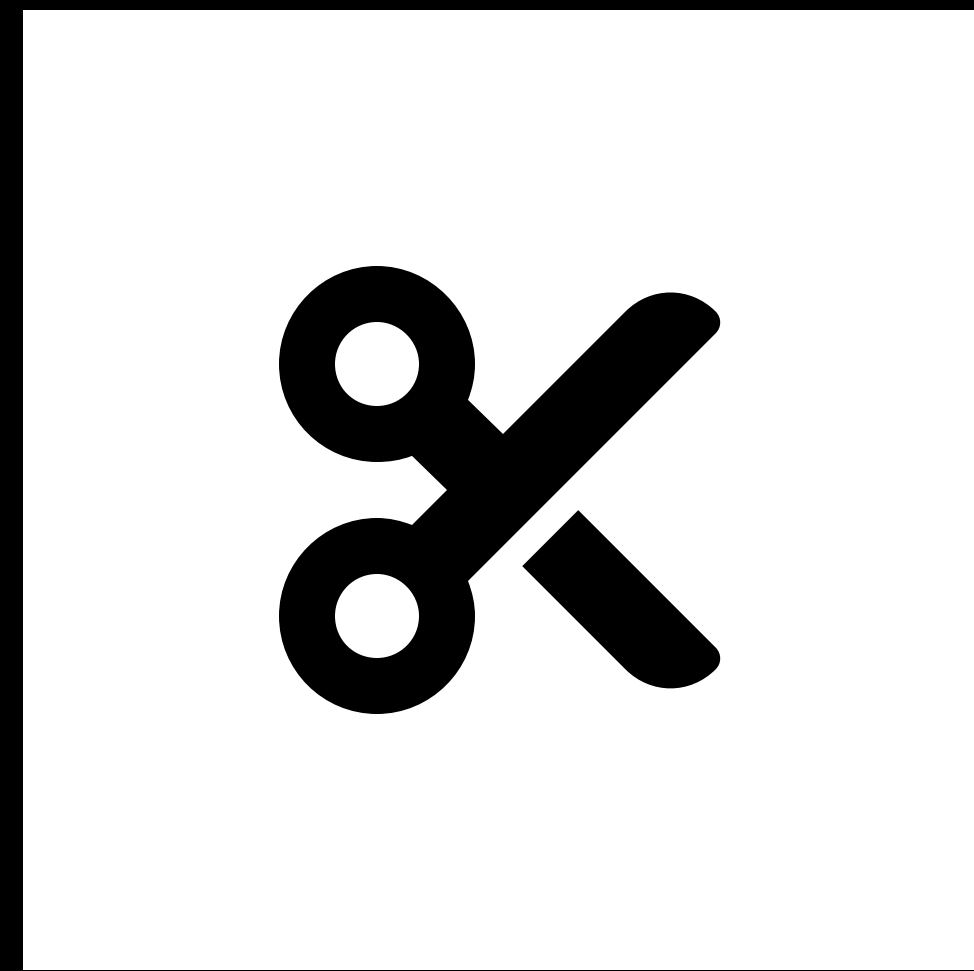

$\geq 24\text{px}$



$\geq 24\text{px}$

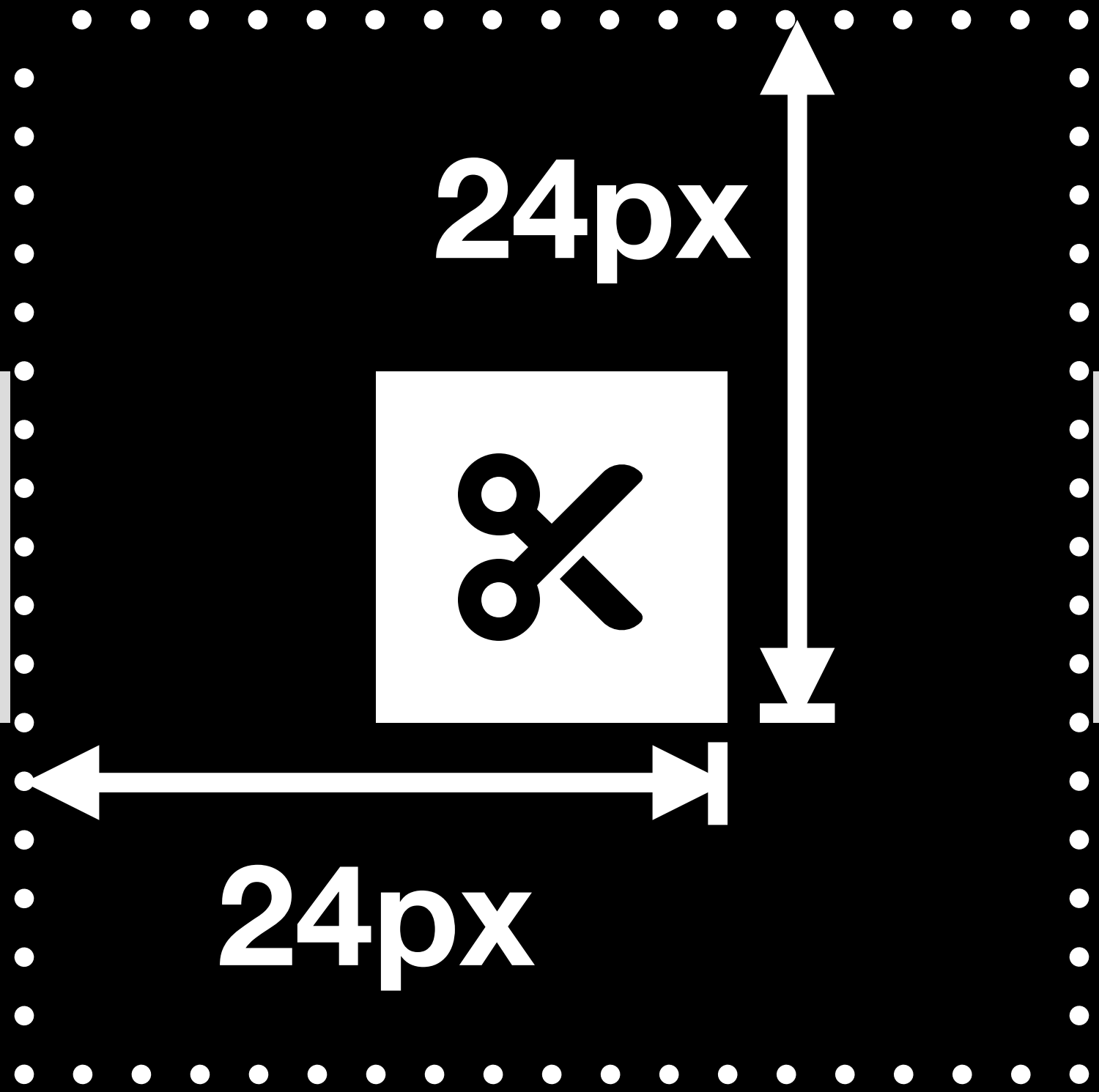
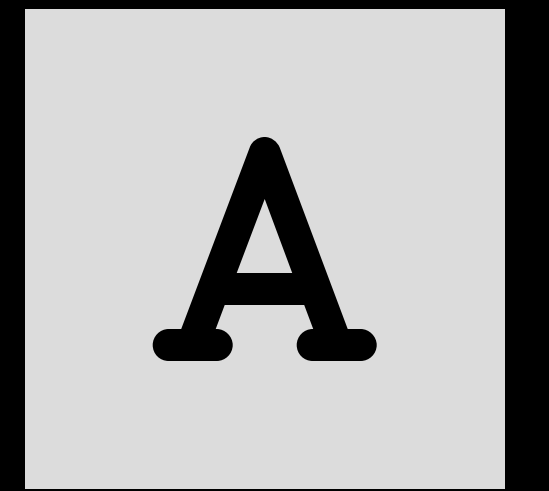
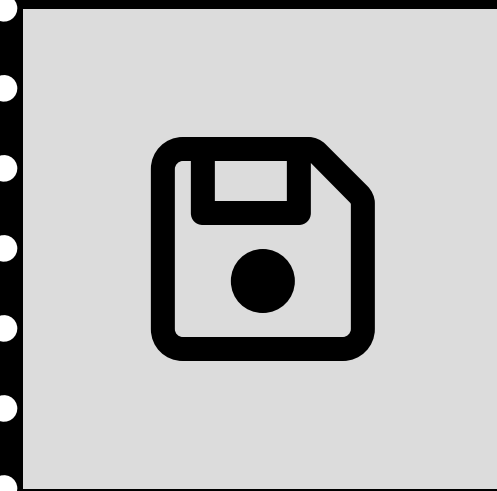
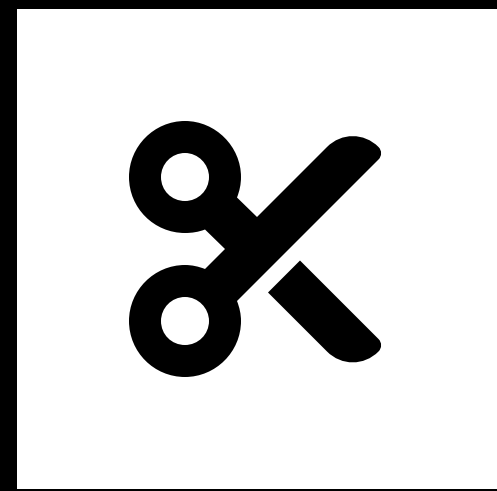
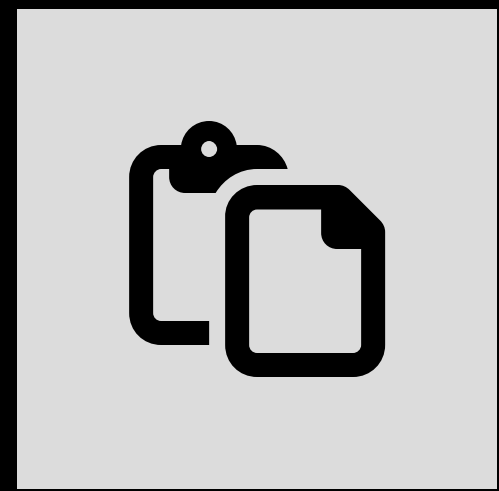
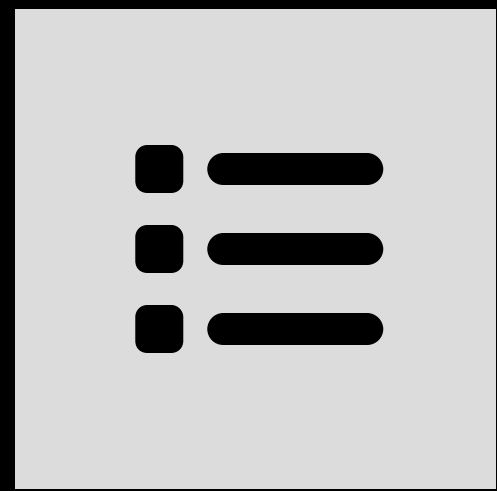

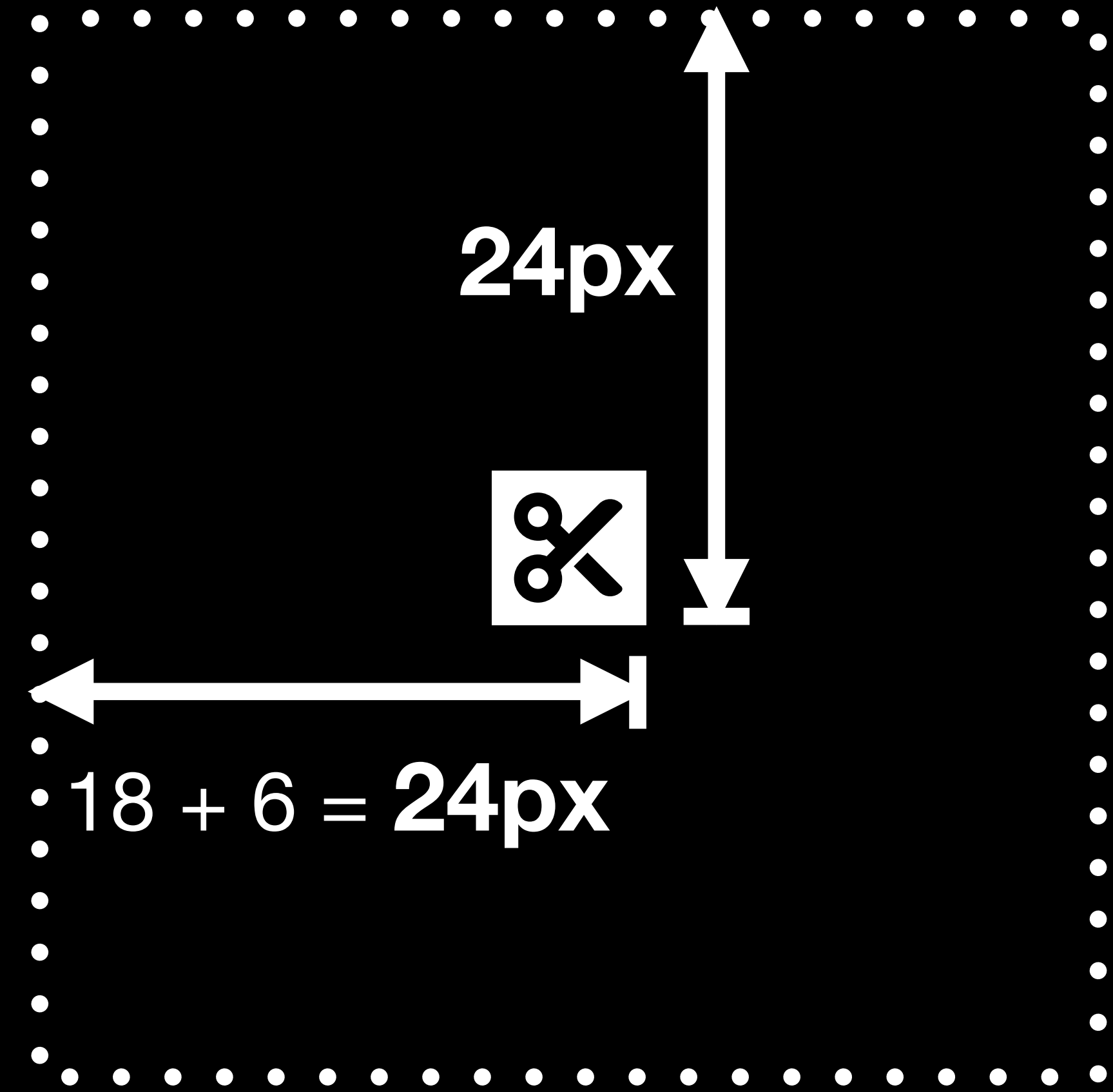
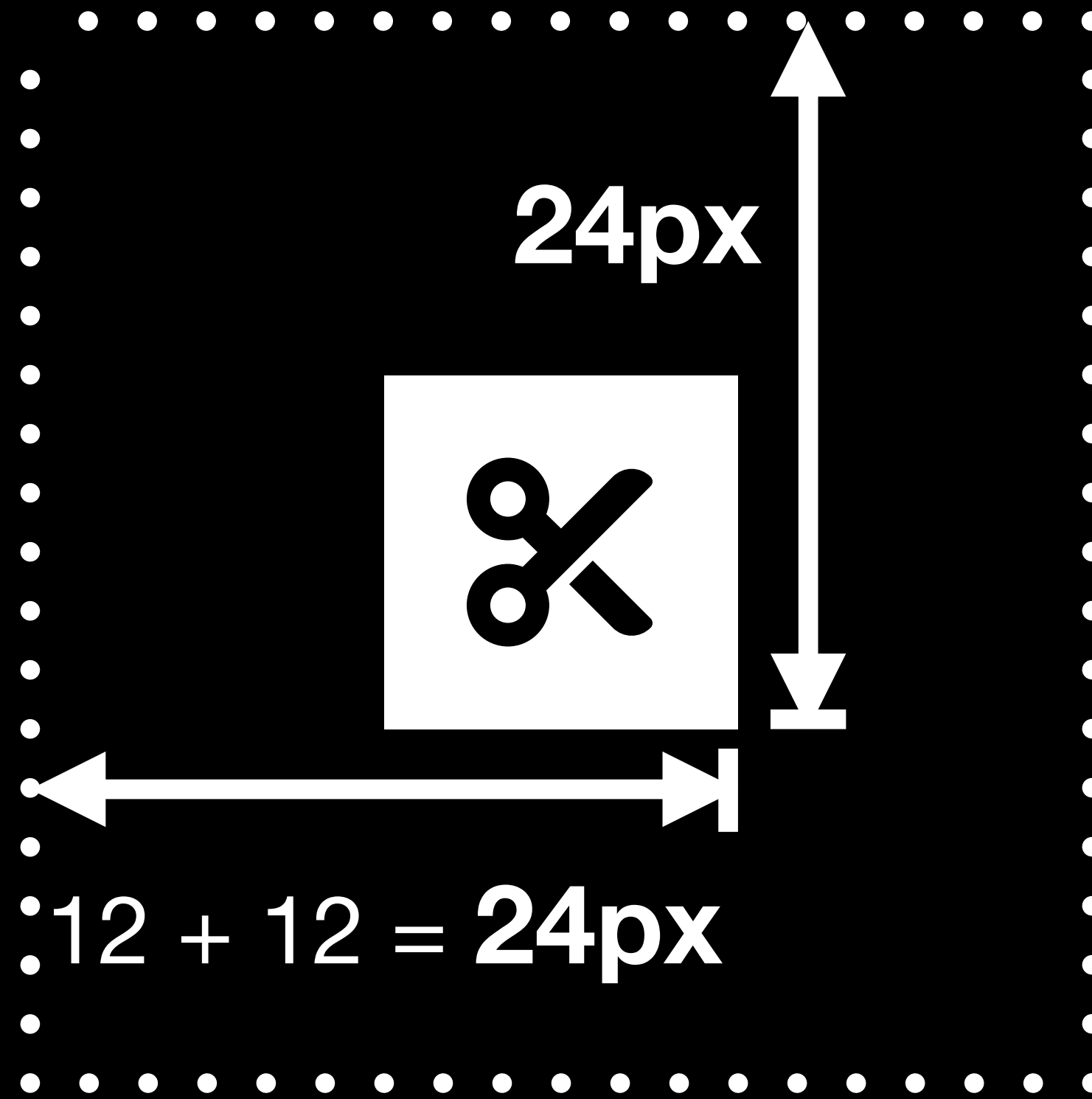
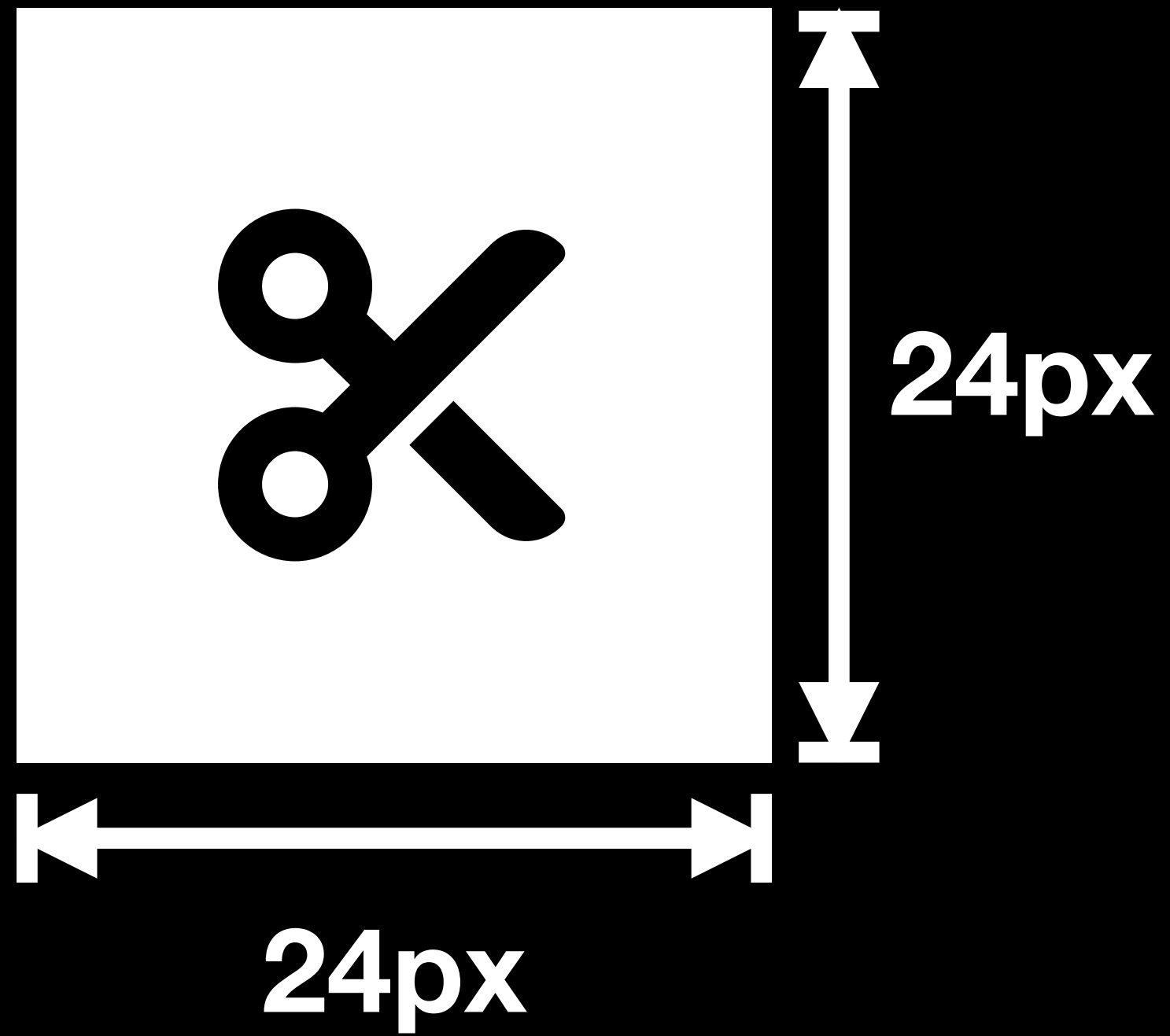

Exemptions

- Inline elements
- Browser-defined elements
- Another conformant element
- Size or spacing is essential
e.g. map pins



Accessible Authentication

AA / AAA

Make it possible to authenticate without
remembering,
transcribing,
or manipulating
any information.

Alternatives

- Biometrics
- Common identifiers:
Name, email, phone number
- USB tokens
- Authentication links
- 3rd party login via OAuth
- WebAuthn (device authentication)



Provide support

for password, one-time code entry

- Copy-paste
- Password manager integration
- Browser autofill



Select all squares with

traffic lights

If there are none, click skip

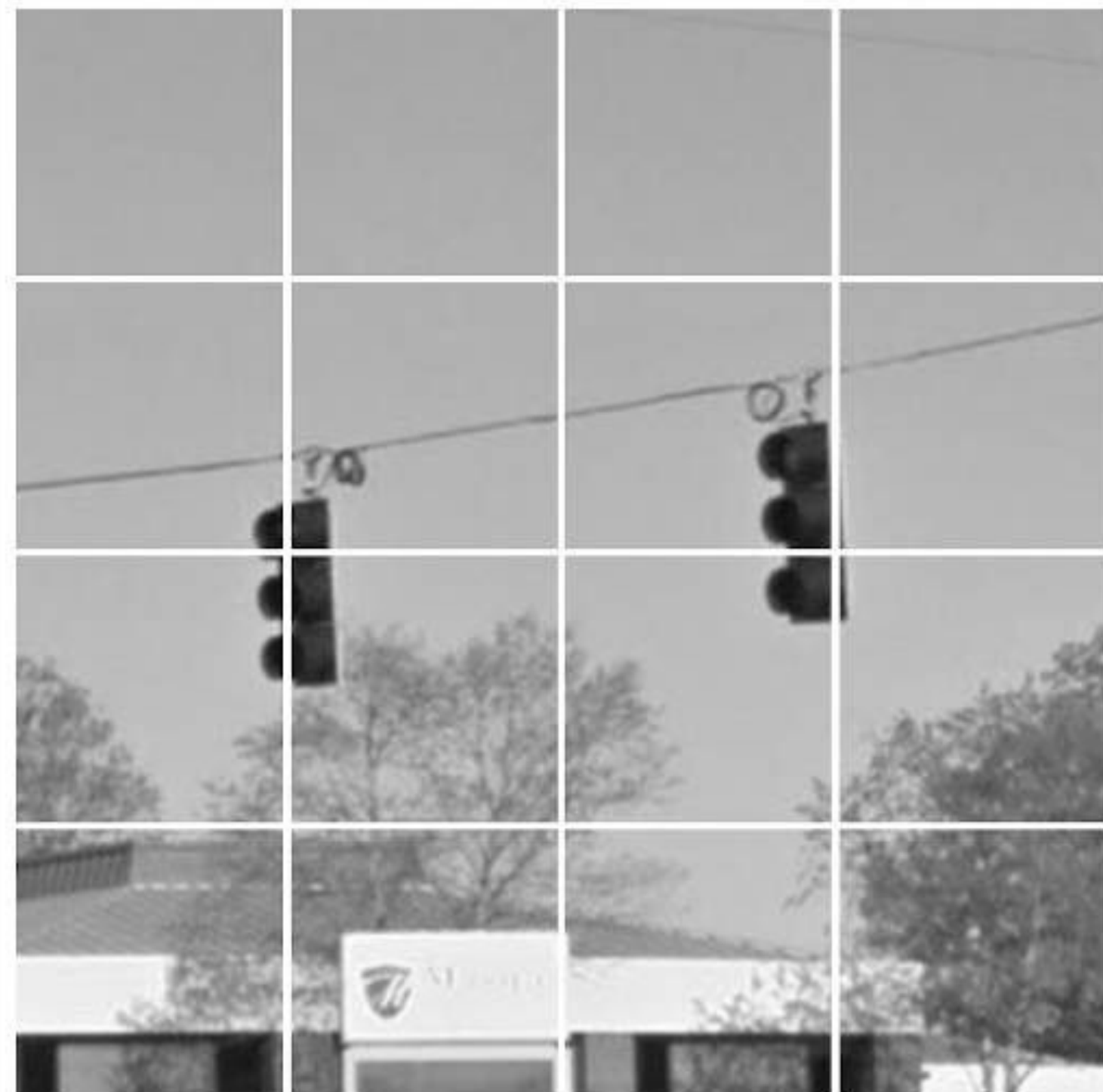

SKIP

More alternatives

AA only

- Recognising generic objects
- Identifying images, audio, or video provided by the user

2.4.7 Focus Visible ($AA \rightarrow A$)



**Visible
keyboard
focus**



Focus Appearance

AA

Submit

- Solid outline
- Focused vs. unfocused contrast $\geq 3:1$
- Adjacent contrast $\geq 3:1$

F

Contrast checks

Focus : Outside $\geq 3:1$
(Adjacent #1)

Focus : Inside $\geq 3:1$
(Adjacent #2)

Focus : Unfocus $\geq 3:1$

I

U

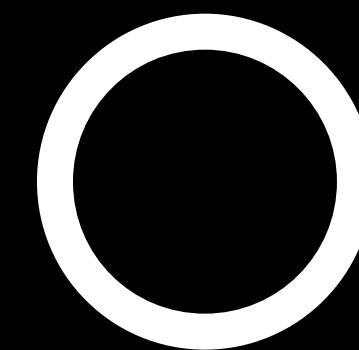

Submit

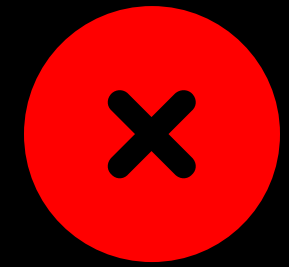

Submit



Cancel



Cancel

Submit



Submit

OK



OK

Delete



Delete

Save



Save

Cancel



Cancel

Submit



Submit

OK



OK

Delete



Delete

Save



Save

- Minimum size (2 options)
- Focused vs. unfocused contrast $\geq 3:1$
- Adjacent contrast $\geq 3:1$ OR focus width $\geq 2\text{px}$

Focus area \geq 1px solid border

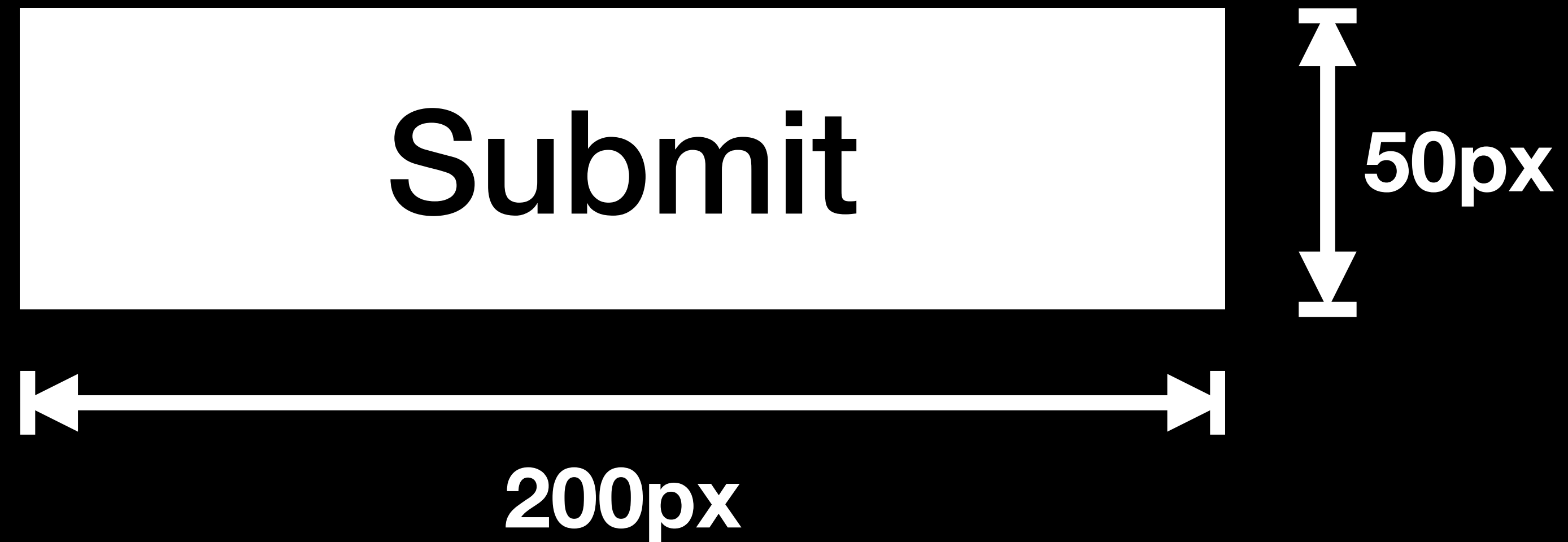

$$200 + 200 + 50 + 50 - 4$$

= **496px** minimum focus area

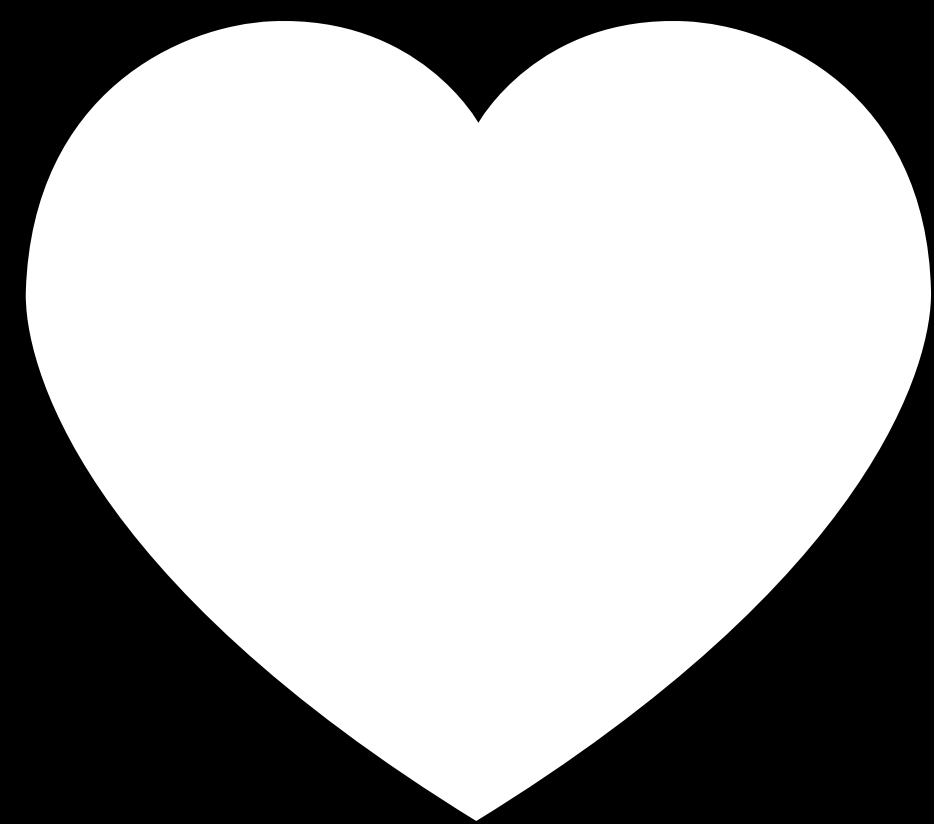

Focus \geq 4px width along shortest side

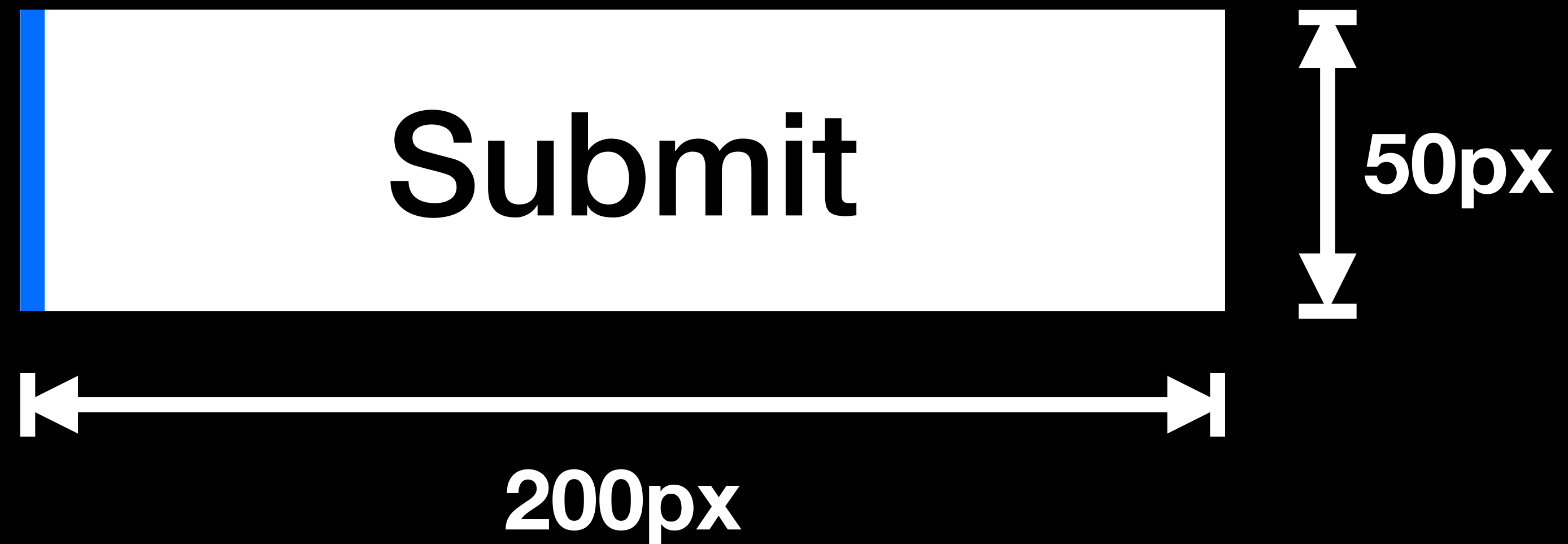

4px \times 50px minimum focus block

Accessible Authentication (AA, AAA)

Consistent Help (A)

Dragging Movements (AA)

Focus Appearance (AA)

Focus Not Obscured (AA, AAA)

Focus Visible (AA → A)

Redundant Entry (A)

Target Size (Minimum) (AA)